

CE EMC Test Report

Report No.: CE190124C20-1

Test Model: ECX-1200 / ECX-1400

Series Model: ECX-1XXXXXXXXXXXXXXXXXXXX ("X" can be 0-9, A-Z or blank for marketing purpose)

Received Date: Jan. 24, 2019

Test Date: Feb. 13, 2019 ~ Mar. 26, 2019

Issued Date: Mar. 29, 2019

Applicant: VECOW CO., LTD.

Address: 12F., No.111, Zhongcheng Rd., Tucheng Dist., New Taipei City 23674, Taiwan (R.O.C.)

Issued By: Bureau Veritas Consumer Products Services (H.K.) Ltd., Taoyuan Branch

Lab Address: No. 47-2, 14th Ling, Chia Pau Vil., Lin Kou Dist., New Taipei City, Taiwan (R.O.C.)

Test Location: No.19, Hwa Ya 2nd Rd., Wen Hwa Vil., Kwei Shan Dist., Taoyuan City 33383, TAIWAN (R.O.C.)



This report is for your exclusive use. Any copying or replication of this report to or for any other person or entity, or use of our name or trademark, is permitted only with our prior written permission. This report sets forth our findings solely with respect to the test samples identified herein. The results set forth in this report are not indicative or representative of the quality or characteristics of the lot from which a test sample was taken or any similar or identical product unless specifically and expressly noted. Our report includes all of the tests requested by you and the results thereof based upon the information that you provided to us. You have 60 days from date of issuance of this report to notify us of any material error or omission caused by our negligence, provided, however, that such notice shall be in writing and shall specifically address the issue you wish to raise. A failure to raise such issue within the prescribed time shall constitute your unqualified acceptance of the completeness of this report, the tests conducted and the correctness of the report contents. Unless specific mention, the uncertainty of measurement has been explicitly taken into account to declare the compliance or non-compliance to the specification. The report must not be used by the client to claim product certification, approval, or endorsement by A2LA or any agency of the federal government. The report must not be used by the client to claim product certification, approval, or endorsement by TAF or any government agencies.

Table of Contents

Release Control Record	5
1 Certificate of Conformity	6
2 Summary of Test Results	7
2.1 Measurement Uncertainty	8
2.2 Modification Record.....	8
3 General Information	9
3.1 General Description of EUT	9
3.2 Operating Modes of EUT and Determination of Worst Case Operating Mode	10
3.3 Test Program Used and Operation Descriptions.....	12
3.4 Primary Clock Frequencies of Internal Source.....	12
3.5 Miscellaneous.....	13
4 Configuration and Connections with EUT	14
4.1 Connection Diagram of EUT and Peripheral Devices	14
4.2 Configuration of Peripheral Devices and Cable Connections	19
5 Conducted Disturbance at Mains Ports	21
5.1 Limits	21
5.2 Test Instruments	21
5.3 Test Arrangement	22
5.4 Test Results	23
6 Asymmetric Mode Conducted Emission at Wired Network Ports	27
6.1 Limits	27
6.2 Test Instruments	27
6.3 Test Arrangement	28
6.4 Test Results	31
7 Radiated Disturbance up to 1 GHz	33
7.1 Limits	33
7.2 Test Instruments	33
7.3 Test Arrangement	34
7.4 Test Results	35
8 Radiated Disturbance above 1 GHz	37
8.1 Limits	37
8.2 Test Instruments	38
8.3 Test Arrangement	39
8.4 Test Results	40
9 Harmonics Current Measurement	42
9.1 Limits	42
9.2 Classification of Equipment	42
9.3 Test Instruments	43
9.4 Test Arrangement	43
9.5 Test Results	44
10 Voltage Fluctuations and Flicker Measurement	50
10.1 Limits	50
10.2 Test Instruments	50
10.3 Test Arrangement	50
10.4 Test Results	51
11 General Immunity Requirements	53

11.1	Specific Immunity Requirements by Manufacturer	54
11.2	Performance Criteria	54
	General Performance Criteria	54
	Product Specific Performance Criteria	55
12	Electrostatic Discharge Immunity Test (ESD).....	56
12.1	Test Specification	56
12.2	Test Instruments	56
12.3	Test Arrangement	56
12.4	Test Results	58
13	Radiated, Radio-frequency, Electromagnetic Field Immunity Test (RS)	73
13.1	Test Specification	73
13.2	Test Instruments	73
13.3	Test Arrangement	74
13.4	Test Results	75
14	Electrical Fast Transient/Burst Immunity Test (EFT).....	76
14.1	Test Specification	76
14.2	Test Instruments	76
14.3	Test Arrangement	77
14.4	Test Results	78
15	Surge Immunity Test.....	79
15.1	Test Specification	79
15.2	Test Instruments	79
15.3	Test Arrangement	80
15.4	Test Results	81
16	Immunity to Conducted Disturbances Induced by RF Fields (CS)	82
16.1	Test Specification	82
16.2	Test Instruments	82
16.3	Test Arrangement	83
16.4	Test Results	84
17	Power Frequency Magnetic Field Immunity Test.....	85
17.1	Test Specification	85
17.2	Test Instruments	85
17.3	Test Arrangement	85
17.4	Test Results	86
18	Voltage Dips and Interruptions.....	87
18.1	Test Specification	87
18.2	Test Instruments	87
18.3	Test Arrangement	87
18.4	Test Results	88
19	Pictures of Test Arrangements.....	89
19.1	Conducted Disturbance at Mains Ports.....	89
19.2	Asymmetric Mode Conducted Emission at Wired Network Ports	90
19.3	Radiated Disturbance up to 1 GHz	91
19.4	Radiated Disturbance above 1 GHz.....	92
19.5	Harmonics Current, Voltage Fluctuations and Flicker Measurement.....	93
19.6	Electrostatic Discharge Immunity Test (ESD)	94
19.7	Radio-frequency, Electromagnetic Field Immunity Test (RS).....	96
19.8	Electrical Fast Transient/Burst Immunity Test (EFT)	99
19.9	Surge Immunity Test.....	102
19.10	Conducted Disturbances Induced by RF Fields (CS)	104

19.11	Power Frequency Magnetic Field Immunity Test (PFMF)	107
19.12	Voltage Dips and Interruptions	109
Appendix – Information of the Testing Laboratories		111

Release Control Record

Issue No.	Description	Date Issued
CE190124C20-1	Original Release	Mar. 29, 2019

1 Certificate of Conformity

Product: Expandable Fanless System
Brand: Vecow
Test Model: ECX-1200 / ECX-1400
Series Model: ECX-1XXXXXXXXXXXXXXXXXXXX ("X" can be 0-9, A-Z or blank for marketing purpose)
Sample Status: MASS-PRODUCTION
Applicant: VECOW CO., LTD.
Test Date: Feb. 13, 2019 ~ Mar. 26, 2019
Standards: **EN 55032:2015 +AC:2016, Class A**
EN 61000-3-2:2014, Class A
EN 61000-3-3:2013
EN 55024:2010
EN 55024:2010 +A1:2015
EN 61000-4-2:2009
EN 61000-4-3:2006 +A1:2008 +A2:2010
EN 61000-4-4:2012
EN 61000-4-5:2014 +A1:2017
EN 61000-4-6:2014 +AC:2015
EN 61000-4-8:2010
EN 61000-4-11:2004 +A1:2017

The above equipment has been tested by **Bureau Veritas Consumer Products Services (H.K.) Ltd., Taoyuan Branch**, and found compliance with the requirement of the above standards. The test record, data evaluation & Equipment Under Test (EUT) configurations represented herein are true and accurate accounts of the measurements of the sample's EMC characteristics under the conditions specified in this report.

Prepared by : Gina Liu , **Date:** Mar. 29, 2019
Gina Liu / Specialist

Approved by : Carl Chen , **Date:** Mar. 29, 2019
Carl Chen / Project Engineer

2 Summary of Test Results

Emission				
Standard	Clause	Test Item	Result/Remarks	Verdict
EN 55032:2015 +AC:2016	A.3	Mains terminal disturbance voltage	Minimum passing Class A margin is -25.14 dB at 5.23275 MHz	Pass
EN 55032:2015 +AC:2016	A.3	Asymmetric mode conducted emission at wired network ports	Minimum passing Class A margin is -6.07 dB at 0.402 MHz	Pass
EN 55032:2015 +AC:2016	A.2	Radiated disturbance 30-1000 MHz	Minimum passing Class A margin is -3.04 dB at 375.00 MHz	Pass
EN 55032:2015 +AC:2016	A.2	Radiated disturbance above 1 GHz	Minimum passing Class A margin is -6.25 dB at 2414.99 MHz	Pass
EN 61000-3-2:2014	-	Harmonic current emissions	Class A The power consumption of EUT is less than 75W and no limits apply.	Pass
EN 61000-3-3:2013	-	Voltage fluctuations and flicker	$P_{st} \leq 1.0$ $d_{max} \leq 4 \%$ $P_{It} \leq 0.65$ $d_c \leq 3.3 \%$ $T_{max} \leq 500 \text{ ms}$	Pass

Immunity				
EN 55024 Clause	Basic standard	Test Item	Result/Remarks	Verdict
4.2.1	EN 61000-4-2:2009	Electrostatic discharges (ESD)	Performance Criterion A	Pass
4.2.3.2	EN 61000-4-3:2006 +A1:2008 +A2:2010	Continuous radiated disturbances (RS)	Performance Criterion A	Pass
4.2.2	EN 61000-4-4:2012	Electrical fast transients (EFT)	Performance Criterion A	Pass
4.2.5	EN 61000-4-5:2014 +A1:2017	Surges	Performance Criterion A	Pass
4.2.3.3	EN 61000-4-6:2014 +AC:2015	Continuous conducted disturbances (CS)	Performance Criterion A	Pass
4.2.4	EN 61000-4-8:2010	Power-frequency magnetic fields (PFMF)	Performance Criterion A	Pass
4.2.6	EN 61000-4-11:2004 +A1:2017	Voltage dips and interruptions	Voltage Dips: >95 % reduction – 0.5 period, Performance Criterion A 30 % reduction – 25 periods, Performance Criterion A Voltage Interruptions: >95 % reduction – 250 periods, Performance Criterion C	Pass

Note:

1. There is no deviation to the applied test methods and requirements covered by the scope of this report.
2. Determining compliance based on the results of the compliance measurement, not taking into account measurement instrumentation uncertainty.

2.1 Measurement Uncertainty

Where relevant, the following measurement uncertainty levels have been estimated for tests performed on the EUT as specified in CISPR 16-4-2:

Measurement	Expanded Uncertainty (k=2) (\pm)	Maximum allowable uncertainty (\pm)
Conducted disturbance at mains port using AMN, 150 kHz ~ 30 MHz	2.44 dB	3.4 dB (U_{CISPR})
Asymmetric mode conducted emission using AAN, 150 kHz ~ 30 MHz	2.69 dB	5.0 dB (U_{CISPR})
Radiated disturbance, 30 MHz ~ 1 GHz	4.70 dB	6.3 dB (U_{CISPR})
Radiated disturbance, 1 GHz ~ 6 GHz	2.26 dB	5.2 dB (U_{CISPR})

2.2 Modification Record

There were no modifications required for compliance.

3 General Information

3.1 General Description of EUT

Product	Expandable Fanless System
Brand	Vecow
Test Model	ECX-1200 / ECX-1400
Series Model	ECX-1XXXXXXXXXXXXXXXXXXXXX ("X" can be 0-9, A-Z or blank for marketing purpose)
Status of EUT	MASS-PRODUCTION
Operating Software	Windows 10
Power Supply Rating	24 Vdc (Adapter)
Accessory Device	Refer to Note as below
Data Cable Supplied	Refer to Note as below

Note:

1. All models are listed as below.

Brand	Model	Difference
Vecow	ECX-1200	The ECX-1200 and ECX-1400 are with different appearance and quantity of slot but same for the electrical and layout.
	ECX-1400	

2. The EUT contains following accessory devices.

Product	Brand	Model	Description
Adapter	Meanwell	GST160A24-R7B	I/P: 100-240 Vac, 50/60 Hz, 2.0 A O/P: 24 Vdc, 6.67 A 1.2m non-shielded cable with 1 core
CPU	Intel	I7-8700	3.2GHz
RAM	Kingston	KVR21S15S8/4	4GB

3. There're 2 configurations for the EUT listed as below.

Sample A: ECX-1400

Sample B: ECX-1200

3.2 Operating Modes of EUT and Determination of Worst Case Operating Mode

Test modes are presented in the report as below.

Mode	Config.	Test Condition
Conducted Emission		
1	A	LAN Link + POE LAN with Camera*4 + USB with M/S + USB with K/B + USB with Flash*3 + RS232 Loop + Mic&Earphone + DP with Monitor*2 + VGA with Monitor + DVI-D Cable + DIO 1&2 Cable + Adapter + CF Card + USB Link Printer
2	A	LAN Link + POE LAN with Camera*4 + USB with M/S + USB with K/B + USB with Flash*3 + RS232 Loop + Mic&Earphone + DP with Monitor*2 + VGA Cable + DVI-D with Monitor + DIO 1&2 Cable + Adapter + CF Card + USB Link Printer
3	B	LAN Link + POE LAN with Camera*4 + USB with M/S + USB with K/B + USB with Flash*3 + RS232 Loop + Mic&Earphone + DP with Monitor*2 + VGA with Monitor + DVI-D Cable + DIO 1&2 Cable + Adapter + CF Card + USB Link Printer
Asymmetric mode conducted emission at wired network ports test		
1	A	LAN Link + POE LAN with Camera*4 + USB with M/S + USB with K/B + USB with Flash*3 + RS232 Loop + Mic&Earphone + DP with Monitor*2 + VGA with Monitor + DVI-D Cable + DIO 1&2 Cable + Adapter + CF Card + USB Link Printer
Radiated Emission		
1	A	LAN Link + POE LAN with Camera*4 + USB with M/S + USB with K/B + USB with Flash*3 + RS232 Loop + Mic&Earphone + DP with Monitor*2 + VGA with Monitor + DVI-D Cable + DIO 1&2 Cable + Adapter + CF Card + USB Link Printer
2	A	LAN Link + POE LAN with Camera*4 + USB with M/S + USB with K/B + USB with Flash*3 + RS232 Loop + Mic&Earphone + DP with Monitor*2 + VGA Cable + DVI-D with Monitor + DIO 1&2 Cable + Adapter + CF Card + USB Link Printer
3	B	LAN Link + POE LAN with Camera*4 + USB with M/S + USB with K/B + USB with Flash*3 + RS232 Loop + Mic&Earphone + DP with Monitor*2 + VGA with Monitor + DVI-D Cable + DIO 1&2 Cable + Adapter + CF Card + USB Link Printer

Remark:

1. For conducted emission test, test mode 1 was the worst case and only this mode was presented in the report.
2. For radiated emission test, we had pre-tested all modes at 230V/50Hz and 110V/60Hz, test mode 1 at 110V/60Hz was the worst case and only this mode was presented in the report.

Mode	Config.	Test Condition
		Harmonics, Flicker, RS, Surge, MF and DIP tests
1	A	LAN Link + POE LAN with Camera*4 + USB with M/S + USB with K/B + USB with Flash*4 + RS232 Loop + Mic&Earphone + DP with Monitor*2 + VGA with Monitor + DVI-D Cable + DIO 1&2 Cable + Adapter + CF Card
2	A	LAN Link + POE LAN with Camera*4 + USB with M/S + USB with K/B + USB with Flash*4 + RS232 Loop + Mic&Earphone + DP with Monitor*2 + VGA Cable + DVI-D with Monitor + DIO 1&2 Cable + Adapter + CF Card
3	B	LAN Link + POE LAN with Camera*4 + USB with M/S + USB with K/B + USB with Flash*4 + RS232 Loop + Mic&Earphone + DP with Monitor*2 + VGA with Monitor + DVI-D Cable + DIO 1&2 Cable + Adapter + CF Card
		ESD test
1	A	LAN Link + POE LAN with Camera*4 + USB with M/S + USB with K/B + USB with HDD*4 + RS232 Loop + Mic&Earphone + DP with Monitor*2 + VGA with Monitor + DVI-D Cable + DIO 1&2 Cable + Adapter + CF Card
2	A	LAN Link + POE LAN with Camera*4 + USB with M/S + USB with K/B + USB with HDD*4 + RS232 Loop + Mic&Earphone + DP with Monitor*2 + VGA Cable + DVI-D with Monitor + DIO 1&2 Cable + Adapter + CF Card
3	B	LAN Link + POE LAN with Camera*4 + USB with M/S + USB with K/B + USB with HDD*4 + RS232 Loop + Mic&Earphone + DP with Monitor*2 + VGA with Monitor + DVI-D Cable + DIO 1&2 Cable + Adapter + CF Card

Mode	Config.	Port	Test Condition
			EFT and CS tests
1	A	-	LAN Link + POE LAN with Camera*4 + USB with M/S + USB with K/B + USB with Flash*4 + RS232 Loop + Mic&Earphone + DP with Monitor*2 + VGA with Monitor + DVI-D Cable + DIO 1&2 Cable + Adapter + CF Card
2	A	-	LAN Link + POE LAN with Camera*4 + USB with M/S + USB with K/B + USB with Flash*4 + RS232 Loop + Mic&Earphone + DP with Monitor*2 + VGA Cable + DVI-D with Monitor + DIO 1&2 Cable + Adapter + CF Card
3	B	-	LAN Link + POE LAN with Camera*4 + USB with M/S + USB with K/B + USB with Flash*4 + RS232 Loop + Mic&Earphone + DP with Monitor*2 + VGA with Monitor + DVI-D Cable + DIO 1&2 Cable + Adapter + CF Card
4	A	LAN1	LAN Link + POE LAN with Camera*4 + USB with M/S + USB with K/B + USB with Flash*4 + RS232 Loop + Mic&Earphone + DP with Monitor*2 + VGA with Monitor + DVI-D Cable + DIO 1&2 Cable + Adapter + CF Card
5	A	POE LAN6	LAN Link + POE LAN with Camera*4 + USB with M/S + USB with K/B + USB with Flash*4 + RS232 Loop + Mic&Earphone + DP with Monitor*2 + VGA with Monitor + DVI-D Cable + DIO 1&2 Cable + Adapter + CF Card
6	B	LAN1	LAN Link + POE LAN with Camera*4 + USB with M/S + USB with K/B + USB with Flash*4 + RS232 Loop + Mic&Earphone + DP with Monitor*2 + VGA with Monitor + DVI-D Cable + DIO 1&2 Cable + Adapter + CF Card
7	B	POE LAN6	LAN Link + POE LAN with Camera*4 + USB with M/S + USB with K/B + USB with Flash*4 + RS232 Loop + Mic&Earphone + DP with Monitor*2 + VGA with Monitor + DVI-D Cable + DIO 1&2 Cable + Adapter + CF Card

3.3 Test Program Used and Operation Descriptions

<Emission Tests>

- a. The EUT was charged from adapter.
- b. The EUT linked with Notebooks via cat5e cables.
- c. The EUT linked with Monitors via DP, DVI and VGA cables.
- d. The EUT read and wrote data with HDDs.
- e. The EUT linked with Printer via USB cable.
- f. The EUT linked with cameras via cat5e cables.
- g. The EUT linked with Terminals, IGN Cables, Ground Cable and DIO Cables.
- h. The EUT communicated data with the Notebooks, which acted as communication partners.

<Immunity Tests>

Test Mode 1, 3, 4, 5

- a. The EUT was charged from adapter.
- b. The EUT linked with Switch Hub via cat5e cables.
- c. The EUT linked with Monitors via VGA and DP cables.
- d. The EUT read and wrote data with HDDs / Flashes.
- e. The EUT linked with cameras via cat5e cables.
- f. The EUT linked with DIO, On/off, GND, DVI cables.
- g. The Switch Hub linked with Notebooks via Cat5e cable
- h. The EUT communicated data with the Notebooks, which acted as communication partners.

Test Mode 2, 6, 7

- a. The EUT was charged from adapter.
- b. The EUT linked with Switch Hub via cat5e cables.
- c. The EUT linked with Monitors via DVI and DP cables.
- d. The EUT read and wrote data with HDDs / Flashes.
- e. The EUT linked with cameras via cat5e cables.
- f. The EUT linked with DIO, On/off, GND, VGA cables.
- g. The Switch Hub linked with Notebooks via Cat5e cable
- h. The EUT communicated data with the Notebooks, which acted as communication partners.

3.4 Primary Clock Frequencies of Internal Source

The highest frequency generated or used within the EUT or on which the EUT operates or tunes is 3.2 GHz, provided by VECOW CO., LTD., for detailed internal source, please refer to the manufacturer's specifications.

3.5 Miscellaneous

➤ Affix CE marking

The marking must be placed visibly and legibly on the product or, if not possible due to the nature of the product, be affixed to the packaging and the accompanying document. The CE marking shall consist of the initials 'CE' taking the following form:

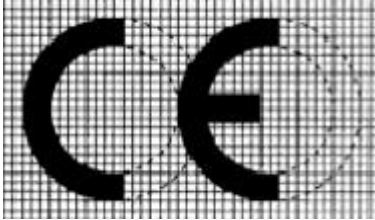

The various components of the CE marking must have the same vertical dimension, and may not be smaller than 5 mm. If the CE marking is reduced or enlarged, the proportions given in the graduated drawing above must be respected.

When the product is subject to other Directives covering other aspects and which also provide for the 'CE' marking, the accompanying documents must indicate that the product also conforms to those other Directives.

However, when one or more of those Directives allow the manufacturer, during a transitional period, to choose which arrangements to apply, the 'CE' marking has to indicate conformity only with the Directives applied by the manufacturer. In this case, the particularities of the Directives applied, as published in the Official Journal of the European Union, must be given in the documents, notices or instructions required by the Directives and accompanying such products.

4 Configuration and Connections with EUT

4.1 Connection Diagram of EUT and Peripheral Devices

Emission tests (Harmonics & Flicker excluded):

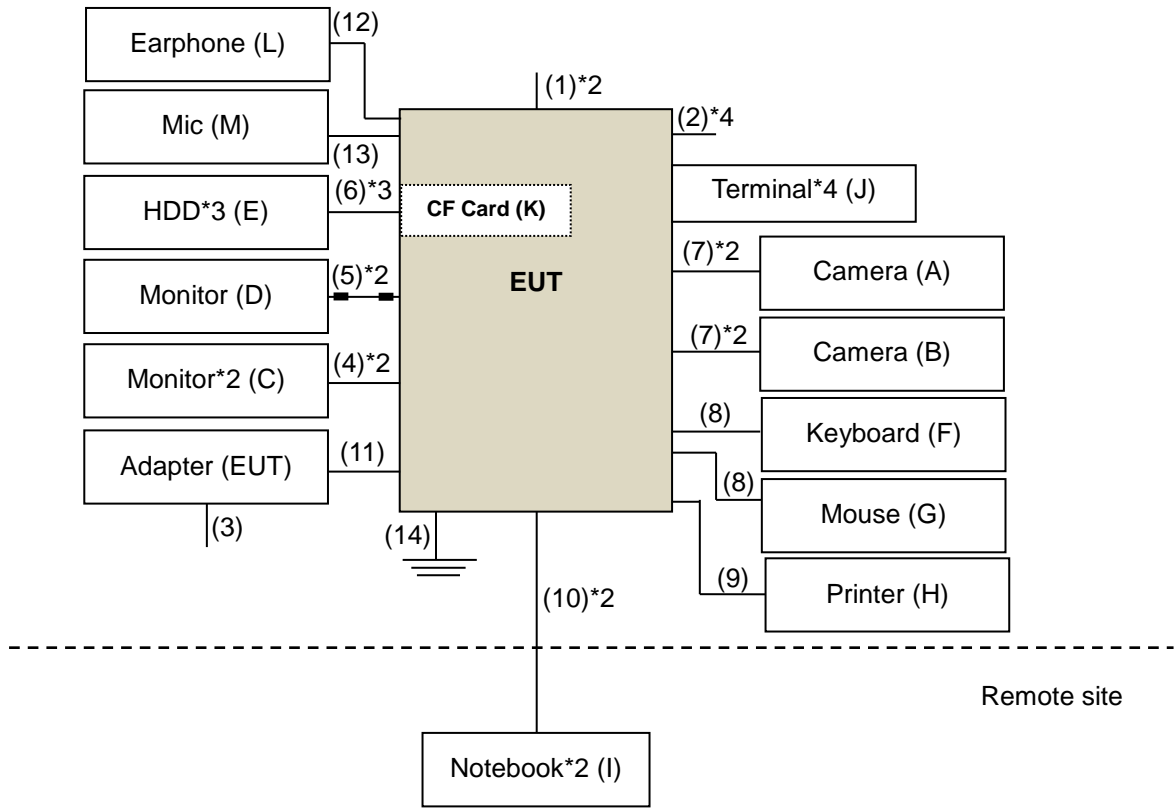

Harmonics, Flicker, Immunity tests (ESD excluded):
 Test Mode 1, 3, 4, 5

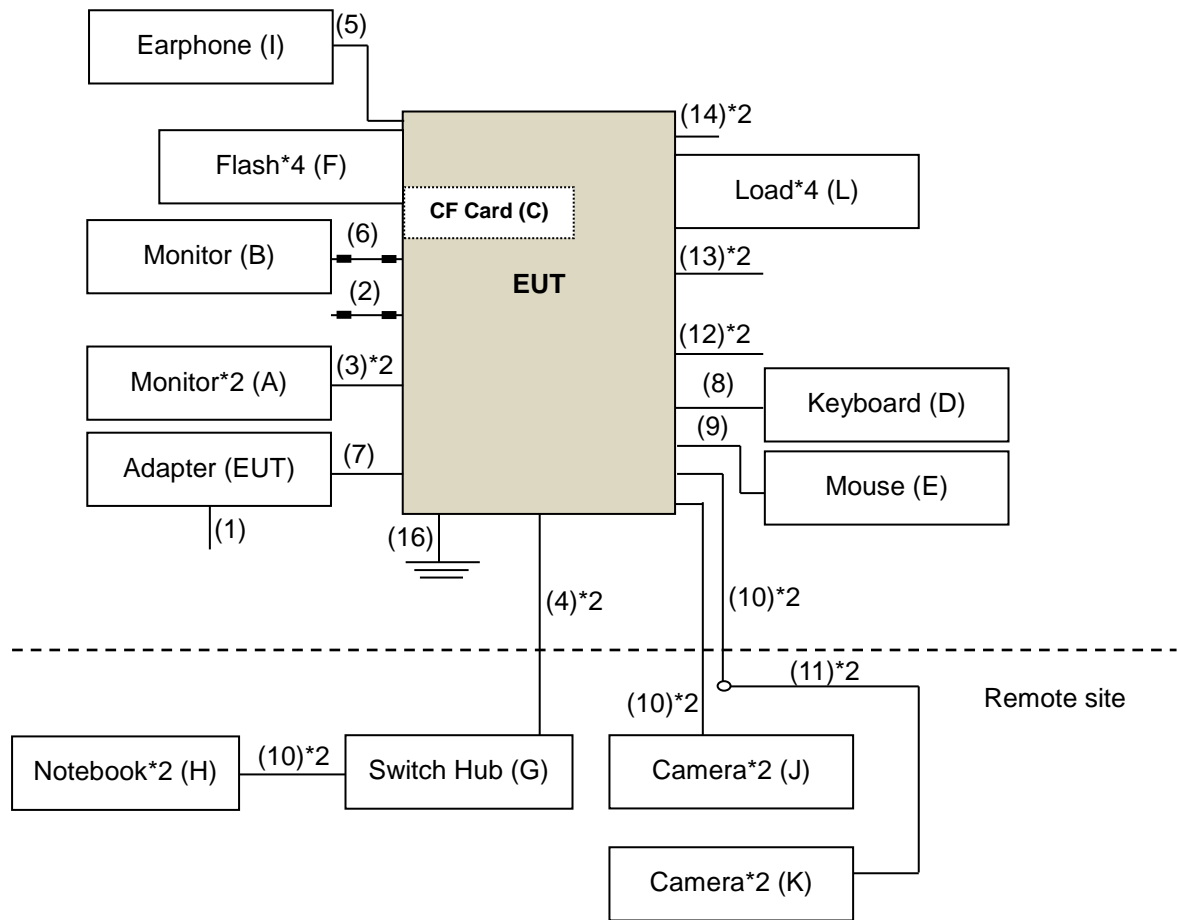

Test Mode 2, 6, 7

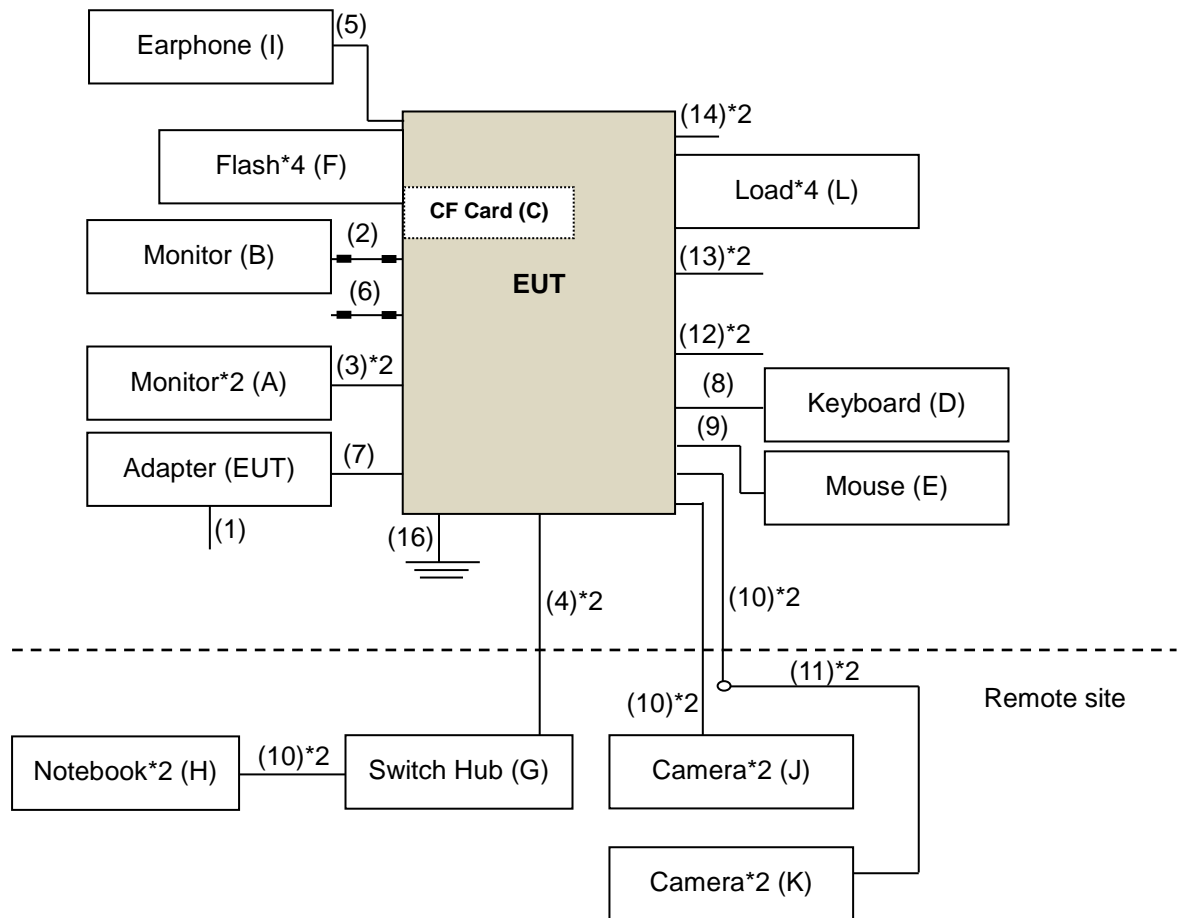

ESD tests:

Test Mode 1, 3

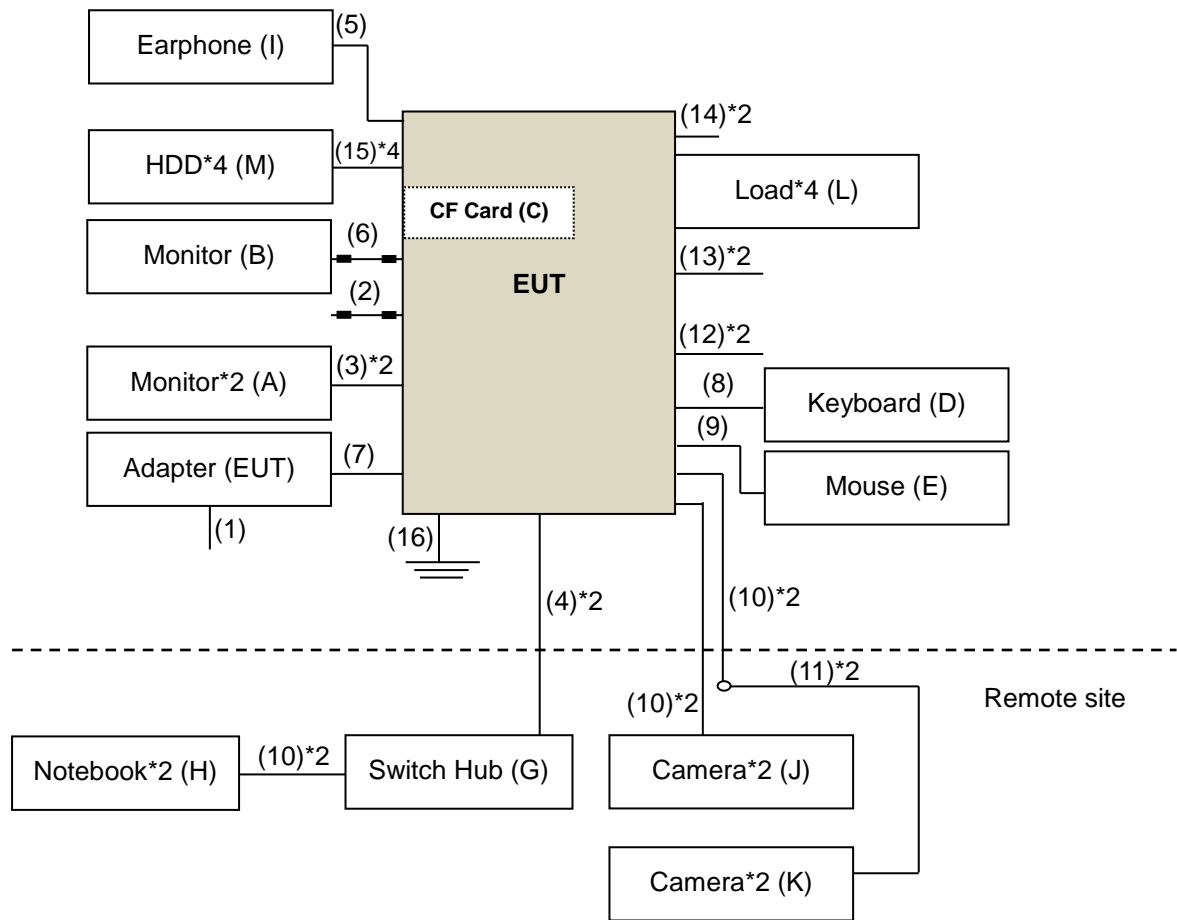

Test Mode 2

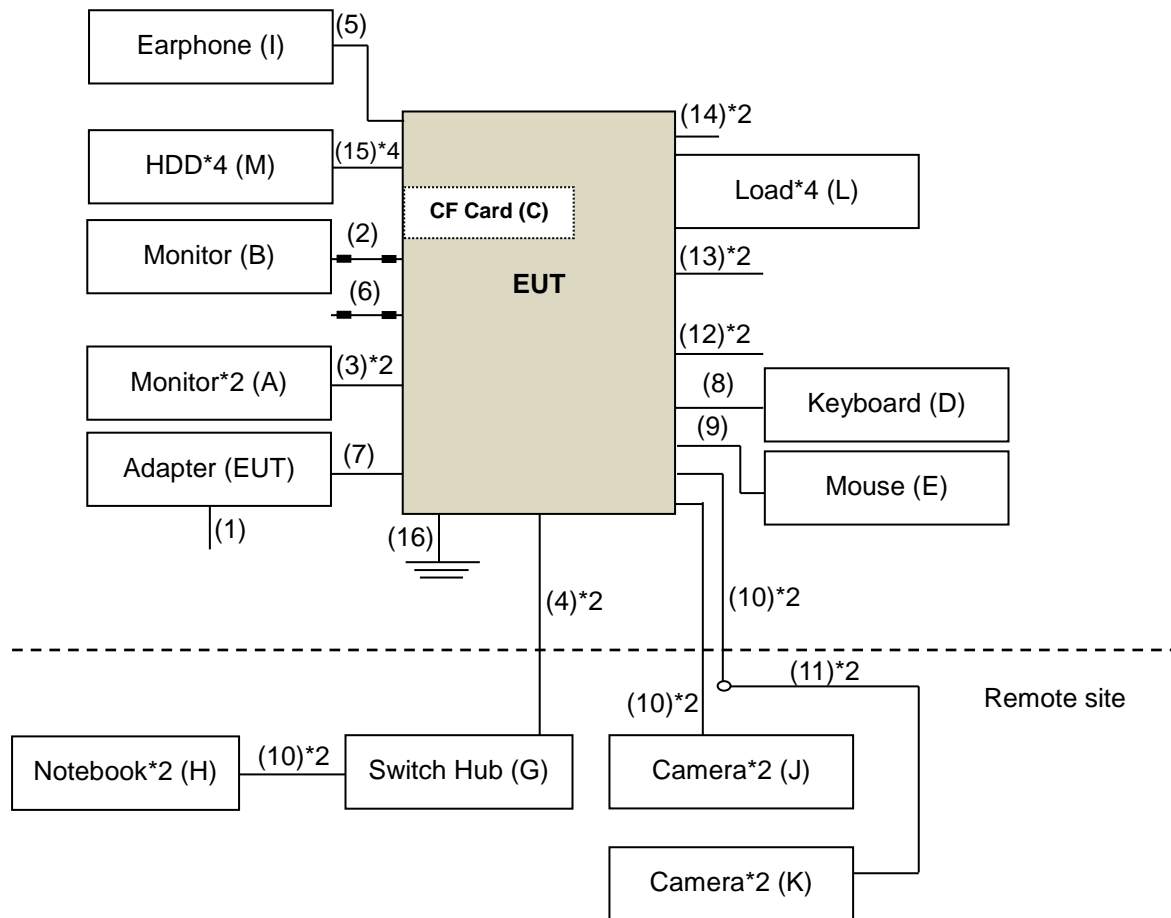

4.2 Configuration of Peripheral Devices and Cable Connections

Emission tests (Harmonics & Flicker excluded):

ID	Product	Brand	Model No.	Serial No.	FCC ID	Remarks
A.	Camera	3MP Modorized	A301R2-0309P	N/A	N/A	Provided by client
B.	Camera	1MAG1NSOU RCE	DMK23GV024	N/A	N/A	Provided by client
C.	Monitor*2	DELL	S2817Q	CN-0GD45P-7444 5-6CD-012M-A01	N/A	--
				CN-0GD45P-7444 5-6CD-010M-A01	N/A	--
D.	Monitor	DELL	U2410	CN-0J257M-7287 2-0A6-02YL	Doc	--
E.	HDD*3	TOSHIBA	DTB305	450KWGVQT3ZB	N/A	--
				45U6CMSST3ZB		
				45U6CMT9T3ZB		
F.	USB Keyboard	DELL	KB216t	CN-0W33XP-LO3 00-79R-OUG8-A0 3	N/A	--
G.	USB Mouse	DELL	MOCZUL	CN-049TWY-PRC 00-79E-02FY	N/A	--
H.	USB PRINTER	EPSON	T22	MEEZ070220	N/A	--
I.	Notebook*2	DELL	E6440	6QLNM32	N/A	--
				FMLNM32		
J.	RS232 Terminal	N/A	N/A	N/A	N/A	Provided by client
K.	CF Card	7nnodisk	CFast3ME3	N/A	N/A	--
L.	EARPHONE	PHILIPS	SBC HL150	NA	N/A	--
M.	MICROPHONE	Labtec	LVA7313	N/A	N/A	--

Note:

- All power cords of the above support units are non-shielded (1.8m).
- Item I acted as communication partner to transfer data.

ID	Descriptions	Qty.	Length (m)	Shielding (Yes/No)	Cores (Qty.)	Remarks
1.	IGN Cable	2	0.55	N	0	
2.	DIO Cable	2	0.9	N	0	
		2	0.3	N	0	
3.	Power Cord	1	1.8	N	0	
4.	DP Cable	2	2.0	Y	0	
5.	VGA Cable	1	2..0	Y	2	
	DVI Cable	1	1.8	Y	2	
6.	USB Cable	3	0.5	Y	0	
7.	Cat5e Cable	4	3.0	N	0	
8.	USB Cable	2	1.8	Y	0	
9.	USB Cable	1	1.8	Y	0	
10.	Cat5e Cable	2	10	N	0	
11.	Adaptee Cable	1	1.2	N	1	Accessory of the EUT
12.	Audio Cable	1	1.8	N	0	
13.	Audio Cable	1	1.8	N	0	
14.	Ground Cable	1	2.0	N	0	

Note: The core(s) is(are) originally attached to the cable(s).

Harmonics, Flicker, Immunity tests:

ID	Product	Brand	Model No.	Serial No.	FCC ID	Remarks
A.	Monitor	AOC	240LM00016	GKAJ5HA117767	N/A	--
		Dell	U2414H 23.8" Monitor	CN-04CWX7-74261-47H-4N9L	N/A	--
B.	Monitor	HP	D7Q14A4	CNC437015Q	N/A	--
C.	CF Card	N/A	N/A	N/A	N/A	Provided by client
D.	Keyboard	Logitech	K120	N/A	N/A	--
E.	Mouse	Logitech	M100r	N/A	N/A	--
F.	USB Flash	Transcend	N/A	N/A	N/A	--
G.	Switch Hub	NETGEAR	GS348	N/A	N/A	--
H.	Notebook PC	DELL	Inspiron 15 3000	JVXSD82	N/A	--
		DELL	Inspiron 15 3000	JBXSD82	N/A	--
I.	Earphone	PHILIPS	SHM2100	N/A	N/A	--
J.	Camera*2	3MP Modorized	A301R2-0309P	N/A	N/A	Provided by client
K.	Camera*2	1MAG1NS OURCE	DMK23GV024	N/A	N/A	Provided by client
L.	Load*4	N/A	N/A	N/A	N/A	Provided by client
M.	USB HDD*4	Transcend	TS1TSJ25MC	N/A	N/A	--

Note:

1. All power cords of the above support units are non-shielded (1.8m).
2. Item H acted as communication partner to transfer data.

ID	Descriptions	Qty.	Length (m)	Shielding (Yes/No)	Cores (Qty.)	Remarks
1.	Power Cord	1	1.8	N	0	
2.	DVI Cable	1	1.8	Y	2	
3.	DP Cable	2	1.8	Y	0	
4.	Cat5e Cable	2	3.0	N	0	
5.	Audio Cable	1	2.0	N	0	
6.	VGA Cable	1	1.8	Y	2	
7.	DC Cable	1	0.65	N	1	
8.	USB Cable	1	1.5	Y	0	
9.	USB Cable	1	1.8	Y	0	
10.	Cat5e Cable	6	3	N	0	
11.	Camera Cable	2	0.45	Y	0	Provided by client
12.	DIO Cable	2	0.35	N	0	
13.	DIO Cable	2	0.9	N	0	
14.	On / Off Cable	2	0.55	N	0	
15.	USB Cable	4	1.18	Y	0	
16.	GND Cable	1	1.6	N	0	

Note: The core(s) is(are) originally attached to the cable(s).

5 Conducted Disturbance at Mains Ports

5.1 Limits

Frequency (MHz)	Class A (dBUV)		Class B (dBUV)	
	Quasi-peak	Average	Quasi-peak	Average
0.15 - 0.5	79	66	66 - 56	56 - 46
0.50 - 5.0	73	60	56	46
5.0 - 30.0	73	60	60	50

Notes: 1. The lower limit shall apply at the transition frequencies.

2. The limit decreases linearly with the logarithm of the frequency in the range of 0.15 to 0.50 MHz.

5.2 Test Instruments

Description & Manufacturer	Model No.	Serial No.	Cal. Date	Cal. Due
Test Receiver ROHDE & SCHWARZ	ESR3	102412	Feb. 14, 2019	Feb. 13, 2020
RF signal cable (with 10dB PAD) Woken	5D-FB	Cable-cond2-01	Sep. 05, 2018	Sep. 04, 2019
AMN ROHDE & SCHWARZ (EUT)	ESH2-Z5	100100	Jan. 30, 2019	Jan. 29, 2020
AMN ROHDE & SCHWARZ (Peripheral)	ESH3-Z5	100312	Aug. 13, 2018	Aug. 12, 2019
Software ADT	BV ADT_Cond_ V7.3.7.4	NA	NA	NA

Note: 1. The calibration interval of the above test instruments is 12 months and the calibrations are traceable to NML/ROC and NIST/USA.

2. The test was performed in HwaYa Shielded Room 2.

3. The VCCI Site Registration No. is C-2047.

5.3 Test Arrangement

- The EUT was placed 0.4 meters from the conducting wall of the shielded room with EUT being connected to the power mains through an Artificial Mains Network (AMN). Other support units were connected to the power mains through another AMN. The two AMNs provide 50 Ohm/ 50 uH of coupling impedance for the measuring instrument.
- Both lines of the power mains connected to the EUT were checked for maximum conducted interference.
- The test results of conducted emissions at mains ports are recorded of six worst margins for quasi-peak (mandatory) [and average (if necessary)] values against the limits at frequencies of interest unless the margin is 20 dB or greater.

Note: The resolution bandwidth and video bandwidth of test receiver is 9 kHz for quasi-peak detection (QP) and average detection (AV) at frequency 0.15 MHz – 30 MHz.

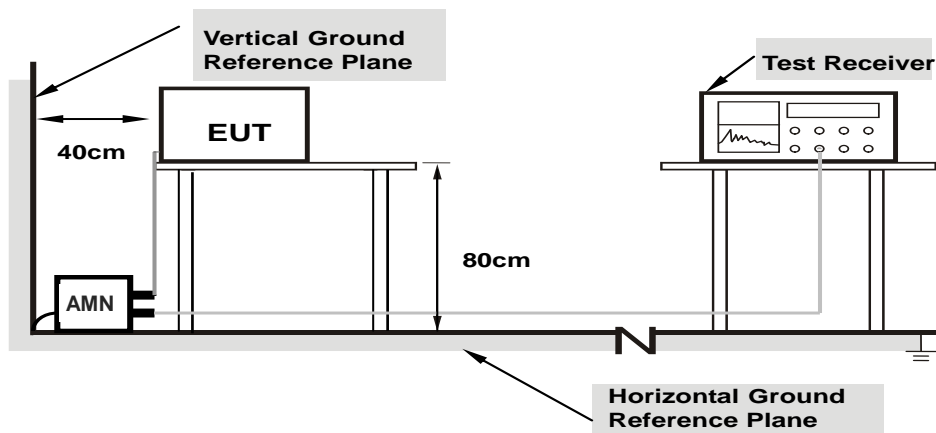

- Note:
- Support units were connected to second AMN.
 - The distance specified between EUT/AE and other metallic objects is ≥ 0.8 m in the measurement arrangement for table-top EUT.
 - According to EN 55032 standard, cables on the RGP must be insulated.

5.4 Test Results

Frequency Range	150kHz ~ 30MHz	Detector Function & Bandwidth	Quasi-Peak (QP) / Average (AV), 9kHz
Input Power	230Vac, 50Hz	Environmental Conditions	25°C, 60%RH
Tested by	Daniel Lin	Test Date	2019/3/18
Test Mode	Mode 1		

Phase Of Power : Line (L)										
No	Frequency (MHz)	Correction Factor (dB)	Reading Value (dBuV)		Emission Level (dBuV)		Limit (dBuV)		Margin (dB)	
			Q.P.	AV.	Q.P.	AV.	Q.P.	AV.	Q.P.	AV.
1	0.18133	10.07	34.56	21.84	44.63	31.91	79.00	66.00	-34.37	-34.09
2	0.27400	10.07	17.45	5.24	27.52	15.31	79.00	66.00	-51.48	-50.69
3	3.19000	10.13	14.62	6.02	24.75	16.15	73.00	60.00	-48.25	-43.85
4	13.23800	10.36	25.09	17.18	35.45	27.54	73.00	60.00	-37.55	-32.46
5	19.09800	10.50	22.73	16.70	33.23	27.20	73.00	60.00	-39.77	-32.80
6	24.12200	10.43	21.92	15.87	32.35	26.30	73.00	60.00	-40.65	-33.70

Remarks:

1. Q.P. and AV. are abbreviations of quasi-peak and average individually.
2. The emission levels of other frequencies were very low against the limit.
3. Margin value = Emission level – Limit value
4. Correction factor = Insertion loss + Cable loss
5. Emission Level = Correction Factor + Reading Value

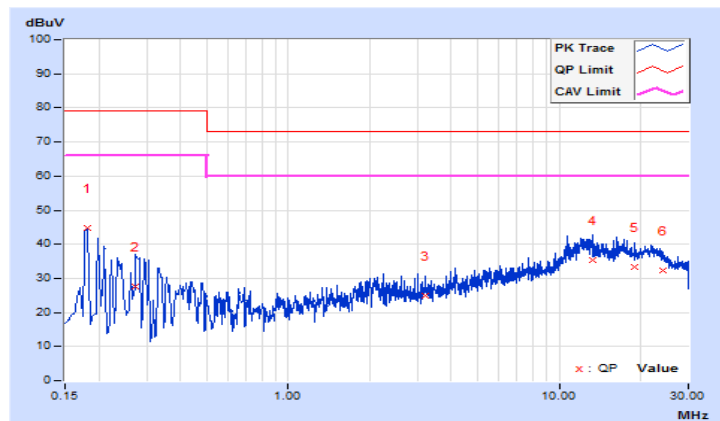

Frequency Range	150kHz ~ 30MHz	Detector Function & Bandwidth	Quasi-Peak (QP) / Average (AV), 9kHz
Input Power	230Vac, 50Hz	Environmental Conditions	25°C, 60%RH
Tested by	Daniel Lin	Test Date	2019/3/18
Test Mode	Mode 1		

Phase Of Power : Neutral (N)										
No	Frequency (MHz)	Correction Factor (dB)	Reading Value (dBuV)		Emission Level (dBuV)		Limit (dBuV)		Margin (dB)	
			Q.P.	AV.	Q.P.	AV.	Q.P.	AV.	Q.P.	AV.
1	0.18228	10.13	34.87	22.59	45.00	32.72	79.00	66.00	-34.00	-33.28
2	0.28602	10.13	24.52	7.36	34.65	17.49	79.00	66.00	-44.35	-48.51
3	5.23000	10.25	22.81	20.58	33.06	30.83	73.00	60.00	-39.94	-29.17
4	10.40200	10.40	22.07	15.18	32.47	25.58	73.00	60.00	-40.53	-34.42
5	16.73400	10.59	26.84	20.28	37.43	30.87	73.00	60.00	-35.57	-29.13
6	23.91800	10.57	27.26	19.82	37.83	30.39	73.00	60.00	-35.17	-29.61

Remarks:

1. Q.P. and AV. are abbreviations of quasi-peak and average individually.
2. The emission levels of other frequencies were very low against the limit.
3. Margin value = Emission level – Limit value
4. Correction factor = Insertion loss + Cable loss
5. Emission Level = Correction Factor + Reading Value

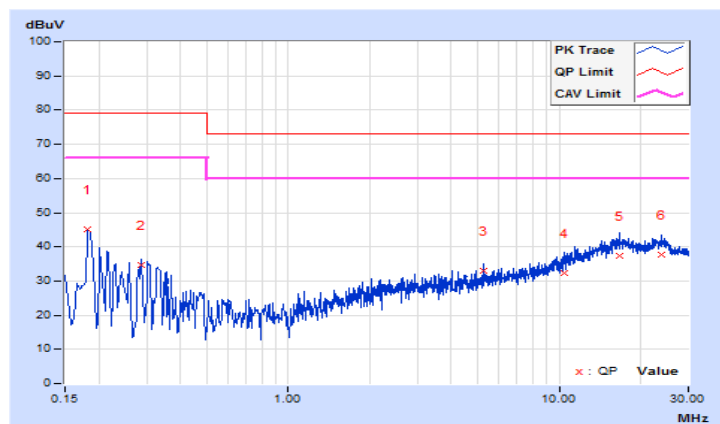

Frequency Range	150kHz ~ 30MHz	Detector Function & Bandwidth	Quasi-Peak (QP) / Average (AV), 9kHz
Input Power	110Vac, 60Hz	Environmental Conditions	25°C, 60%RH
Tested by	Daniel Lin	Test Date	2019/3/18
Test Mode	Mode 1		

Phase Of Power : Line (L)										
No	Frequency (MHz)	Correction Factor (dB)	Reading Value (dBuV)		Emission Level (dBuV)		Limit (dBuV)		Margin (dB)	
			Q.P.	AV.	Q.P.	AV.	Q.P.	AV.	Q.P.	AV.
1	0.17025	10.07	36.20	22.80	46.27	32.87	79.00	66.00	-32.73	-33.13
2	0.25800	10.07	29.60	21.70	39.67	31.77	79.00	66.00	-39.33	-34.23
3	0.40229	10.07	16.34	12.80	26.41	22.87	79.00	66.00	-52.59	-43.13
4	6.91575	10.21	19.21	11.97	29.42	22.18	73.00	60.00	-43.58	-37.82
5	12.05025	10.33	26.67	18.04	37.00	28.37	73.00	60.00	-36.00	-31.63
6	16.56150	10.44	26.74	20.59	37.18	31.03	73.00	60.00	-35.82	-28.97

Remarks:

1. Q.P. and AV. are abbreviations of quasi-peak and average individually.
2. The emission levels of other frequencies were very low against the limit.
3. Margin value = Emission level – Limit value
4. Correction factor = Insertion loss + Cable loss
5. Emission Level = Correction Factor + Reading Value

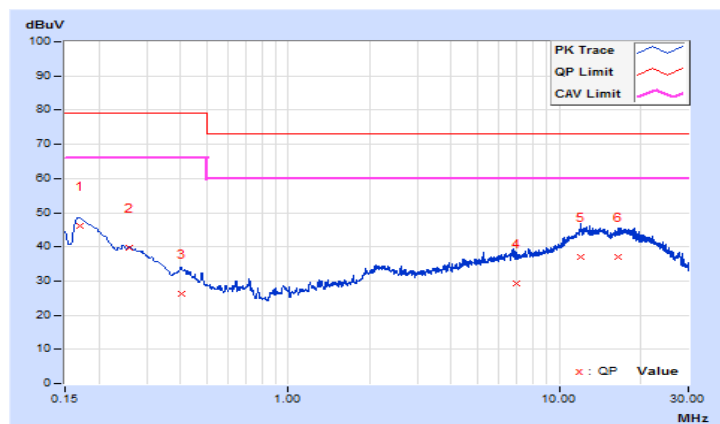

Frequency Range	150kHz ~ 30MHz	Detector Function & Bandwidth	Quasi-Peak (QP) / Average (AV), 9kHz
Input Power	110Vac, 60Hz	Environmental Conditions	25°C, 60%RH
Tested by	Daniel Lin	Test Date	2019/3/18
Test Mode	Mode 1		

Phase Of Power : Neutral (N)										
No	Frequency (MHz)	Correction Factor (dB)	Reading Value (dBuV)		Emission Level (dBuV)		Limit (dBuV)		Margin (dB)	
			Q.P.	AV.	Q.P.	AV.	Q.P.	AV.	Q.P.	AV.
1	0.16393	10.12	29.67	16.20	39.79	26.32	79.00	66.00	-39.21	-39.68
2	0.26577	10.13	23.88	12.59	34.01	22.72	79.00	66.00	-44.99	-43.28
3	5.23275	10.25	26.94	24.61	37.19	34.86	73.00	60.00	-35.81	-25.14
4	18.05550	10.63	29.92	23.57	40.55	34.20	73.00	60.00	-32.45	-25.80
5	23.30700	10.59	28.06	21.12	38.65	31.71	73.00	60.00	-34.35	-28.29
6	23.30700	10.59	28.10	21.27	38.69	31.86	73.00	60.00	-34.31	-28.14

Remarks:

1. Q.P. and AV. are abbreviations of quasi-peak and average individually.
2. The emission levels of other frequencies were very low against the limit.
3. Margin value = Emission level – Limit value
4. Correction factor = Insertion loss + Cable loss
5. Emission Level = Correction Factor + Reading Value

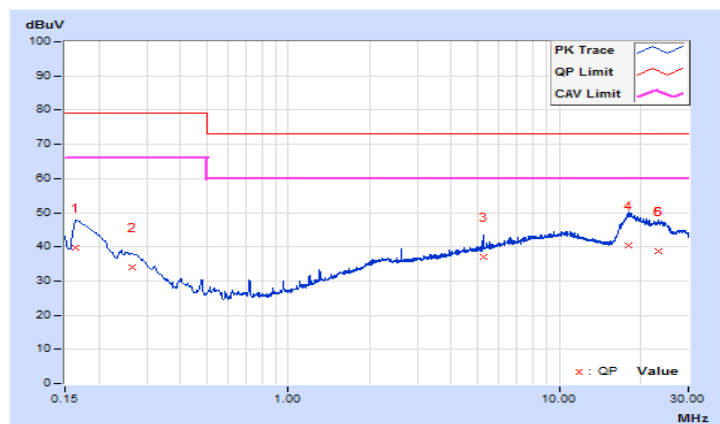

6 Asymmetric Mode Conducted Emission at Wired Network Ports

6.1 Limits

Class A					
Frequency (MHz)	Coupling Device	Voltage Limit (dBuV)		Current limits (dBuA)	
		Quasi-peak	Average	Quasi-peak	Average
0.15-0.5	AAN	97-87	84-74	-	-
0.5-30		87	74	-	-
0.15-0.5	CVP and Current probe	97-87	84-74	53-43	40-30
0.5-30		87	74	43	30
0.15-0.5	Current Probe	-	-	53-43	40-30
0.5-30		-	-	43	30
Class B					
Frequency (MHz)	Coupling Device	Voltage Limit (dBuV)		Current limits (dBuA)	
		Quasi-peak	Average	Quasi-peak	Average
0.15-0.5	AAN	84-74	74-64	-	-
0.5-30		74	64	-	-
0.15-0.5	CVP and Current probe	84-74	74-64	40-30	30-20
0.5-30		74	64	30	20
0.15-0.5	Current Probe	-	-	40-30	30-20
0.5-30		-	-	30	20

Note: The limits decrease linearly with the logarithm of the frequency in the range 0.15 MHz to 0.5 MHz.

6.2 Test Instruments

Description & Manufacturer	Model No.	Serial No.	Cal. Date	Cal. Due
Test Receiver ROHDE & SCHWARZ	ESR3	102412	Feb. 14, 2019	Feb. 13, 2020
RF signal cable (with 10dB PAD) Woken	5D-FB	Cable-cond2-01	Sep. 05, 2018	Sep. 04, 2019
AMN ROHDE & SCHWARZ (EUT)	ESH2-Z5	100100	Jan. 30, 2019	Jan. 29, 2020
AMN ROHDE & SCHWARZ (Peripheral)	ESH3-Z5	100312	Aug. 13, 2018	Aug. 12, 2019
Software ADT	BV ADT_Cond_ V7.3.7.4	NA	NA	NA
AAN	FCC-TLISN-T2-02-09	091393	Dec. 22, 2018	Dec. 21, 2019
AAN	F-071115-1057-1-09	120033	May 09, 2018	May 08, 2019
Capacitive Voltage Probe	F-CVP-1	82	Jul. 20, 2018	Jul. 19, 2019
RF Current Probe	F-33-4	45	Mar. 08, 2019	Mar. 07, 2020
Impedance-stabilization-network TESEQ	ISN ST08	41211	Aug. 17, 2018	Aug. 16, 2019
Impedance-stabilization-network TESEQ	ISN S751	40600	Aug. 17, 2018	Aug. 16, 2019

Notes: 1. The calibration interval of the above test instruments is 12 months and the calibrations are traceable to NML/ROC and NIST/USA.

2. The test was performed in HwaYa Shielded Room 2.

3. The VCCI Site Registration No. is T-11654.

6.3 Test Arrangement

Method of Using AANs:

- The EUT is placed 0.4 meters from the conducting wall of the shielded room and connected to AAN directly to reference ground plane.
- If voltage measurement is used, measure voltage at the measurement port of the AAN, correct the reading by adding the AAN voltage division factor, and compare to the voltage limit.
- If current measurement is used, measure current with the current probe and compare to the current limit. A 50 Ω load has to be connected to the measurement port of the AAN during the current measurement.
- It is not necessary to apply the voltage and the current limit if a AAN is used.
- The test results of disturbance at wired network ports are recorded of six worst margins for quasi-peak (mandatory) [and average (if necessary)] values against the limits at frequencies of interest unless the margin is 20 dB or greater.

Note: The resolution bandwidth and video bandwidth of test receiver is 9 kHz for quasi-peak detection (QP) and average detection (AV) at frequency 0.15 MHz – 30 MHz.

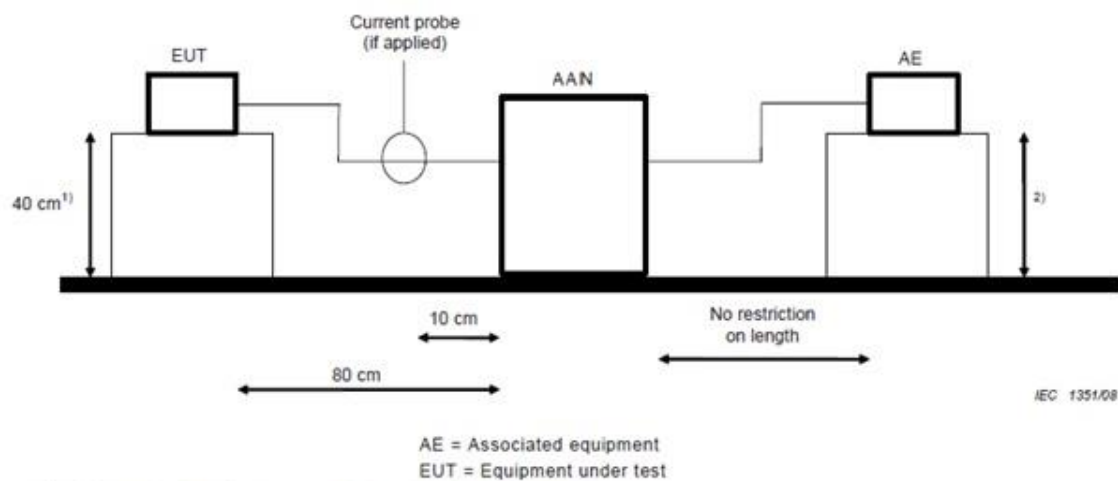

- Note:
- Distance to the reference ground plane (vertical or horizontal).
 - Distance to the reference ground plane is not critical.
 - According to EN 55032 standard, cables on the RGP must be insulated.

Method of Using a 150 Ω load to the outside surface of the shield:

- Break the insulation and connect a 150Ω resistor from the outside surface of the shield to ground.
- Apply a clamp between 150Ω connection and associated equipment.
- Current probe shall be placed at 0.1 m from the AAN.
- Measure current with a current probe and compare to the current limit.
- Voltage measurement is also possible either in parallel with the 150 Ω resistor with a high impedance probe. (only for a high impedance probe applied, replaced d. if this is the case)
- Voltage measurement by using a "50 Ω to 150 Ω adaptor" described in IEC 61000-4-6 as 150 Ω load, and applying the appropriate correction factor (9,6 dB in case of the "50 Ω to 150 Ω adaptor"). (only for 50 Ω to 150 Ω adaptor applied, replaced d. if this is the case.)
- The test results of disturbance at telecommunication ports are recorded of six worst margins for quasi-peak (mandatory) [and average (if necessary)] values against the limits at frequencies of interest unless the margin is 20 dB or greater.

Note: The resolution bandwidth and video bandwidth of test receiver is 9 kHz for quasi-peak detection (QP) and average detection (AV) at frequency 0.15 MHz - 30 MHz.

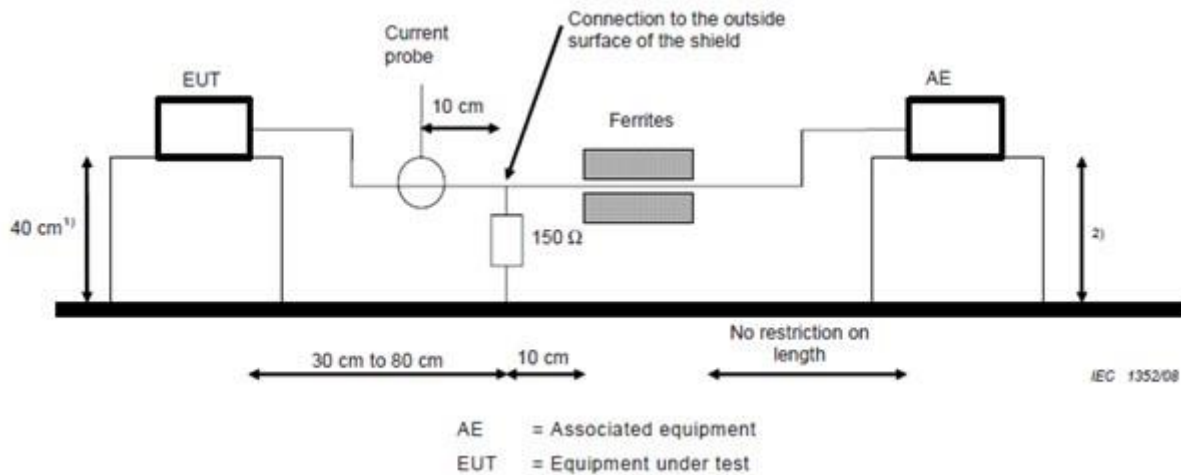

- Note:
- Distance to the reference ground plane (vertical or horizontal).
 - Distance to the reference ground plane is not critical.
 - According to EN 55032 standard, cables on the RGP must be insulated.

Method of Using a combination of current probe and capacitive voltage probe:

- a. Measure current with a current probe.
- b. Compare the measured current with the applicable current limit.
- c. Measure voltage with a capacitive probe as specified in 5.2.2 of CISPR 16-1-2.
- d. Adjust the measured voltage as follows:
 - current margin ≤ 6 dB – subtract the actual current margin from measured voltage;
 - current margin > 6 dB – subtract 6 dB from measured voltage.
- e. Compare adjusted voltage with the applicable voltage limit
- f. Both the measured current and the adjusted voltage shall be below the applicable
- g. The test results of disturbance at telecommunication ports are recorded of six worst margins for quasi-peak (mandatory) [and average (if necessary)] values against the limits at frequencies of interest unless the margin is 20 dB or greater.

Note: The resolution bandwidth and video bandwidth of test receiver is 9 kHz for quasi-peak detection (QP) and average detection (AV) at frequency 0.15 MHz – 30 MHz.

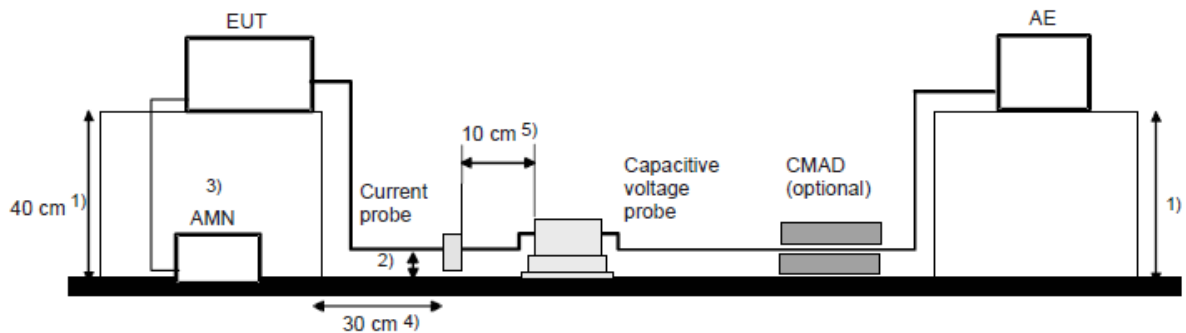

IEC 1353/08

AE = Associated equipment
EUT = Equipment under test

Note: 1. According to EN 55032 standard, cables on the RGP must be insulated.

6.4 Test Results

Frequency Range	150kHz ~ 30MHz	Detector Function & Bandwidth	Quasi-Peak (QP) / Average (AV), 9kHz
Input Power	230Vac, 50Hz	Environmental Conditions	25°C, 60%RH
Tested by	Daniel Lin	Test Date	2019/3/18
Test Mode	LAN1 port with ISN (1Gbps, RUN Traffic)		

No	Frequency (MHz)	Correction Factor (dB)	Reading Value (dBuV)		Emission Level (dBuV)		Limit (dBuV)		Margin (dB)	
			Q.P.	AV.	Q.P.	AV.	Q.P.	AV.	Q.P.	AV.
1	1.33583	9.21	43.04	27.41	52.25	36.62	87.00	74.00	-34.75	-37.38
2	1.83000	9.16	45.37	29.00	54.53	38.16	87.00	74.00	-32.47	-35.84
3	2.37400	9.14	44.74	28.16	53.88	37.30	87.00	74.00	-33.12	-36.70
4	11.23000	9.22	38.40	29.78	47.62	39.00	87.00	74.00	-39.38	-35.00
5	24.42600	9.57	36.53	30.69	46.10	40.26	87.00	74.00	-40.90	-33.74
6	26.71400	9.65	36.58	30.90	46.23	40.55	87.00	74.00	-40.77	-33.45

Remarks:

1. Q.P. and AV. are abbreviations of quasi-peak and average individually.
2. The emission levels of other frequencies were very low against the limit.
3. Margin value = Emission level – Limit value
4. Correction factor = Insertion loss + Cable loss
5. Emission Level = Correction Factor + Reading Value

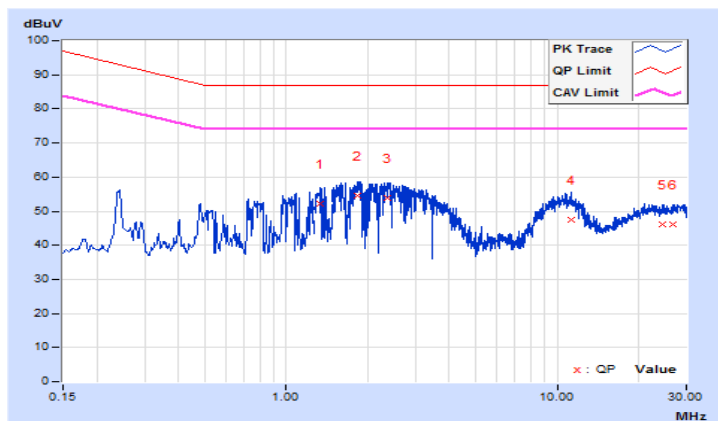

Frequency Range	150kHz ~ 30MHz	Detector Function & Bandwidth	Quasi-Peak (QP) / Average (AV), 9kHz
Input Power	230Vac, 50Hz	Environmental Conditions	25°C, 60%RH
Tested by	Daniel Lin	Test Date	2019/3/18
Test Mode	Mode 3: POE port with ISN (1Gbps, RUN Traffic)		

No	Frequency (MHz)	Correction Factor (dB)	Reading Value (dBuV)		Emission Level (dBuV)		Limit (dBuV)		Margin (dB)	
			Q.P.	AV.	Q.P.	AV.	Q.P.	AV.	Q.P.	AV.
1	0.24200	9.56	62.88	58.20	72.44	67.76	93.03	80.03	-20.59	-12.27
2	0.40200	9.44	62.62	60.30	72.06	69.74	88.81	75.81	-16.75	-6.07
3	1.30600	9.22	55.69	54.44	64.91	63.66	87.00	74.00	-22.09	-10.34
4	5.22926	9.12	56.24	55.62	65.36	64.74	87.00	74.00	-21.64	-9.26
5	10.46200	9.20	40.54	34.31	49.74	43.51	87.00	74.00	-37.26	-30.49
6	20.25800	9.42	38.60	35.12	48.02	44.54	87.00	74.00	-38.98	-29.46

Remarks:

1. Q.P. and AV. are abbreviations of quasi-peak and average individually.
2. The emission levels of other frequencies were very low against the limit.
3. Margin value = Emission level – Limit value
4. Correction factor = Insertion loss + Cable loss
5. Emission Level = Correction Factor + Reading Value

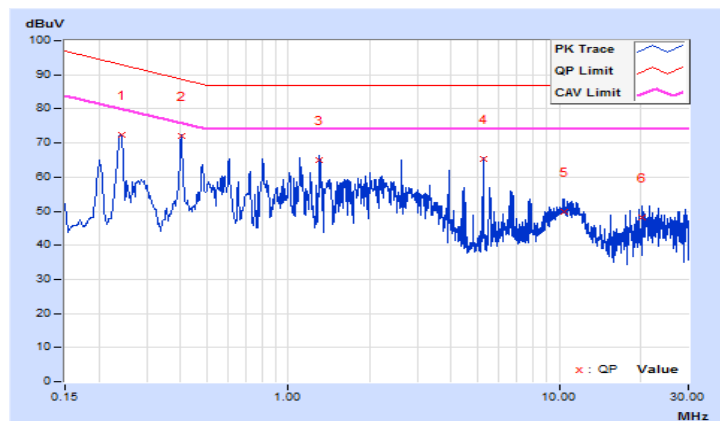

7 Radiated Disturbance up to 1 GHz

7.1 Limits

Frequency (MHz)	Class A (at 10 m)	Class B (at 10 m)
	dBuV/m	dBuV/m
30 - 230	40	30
230 - 1000	47	37

Notes:

1. The lower limit shall apply at the transition frequencies.
2. Emission level (dBuV/m) = 20 log Emission level (uV/m).
3. All emanations from a class A/B digital device or system, including any network of conductors and apparatus connected thereto, shall not exceed the level of field strengths specified above.

7.2 Test Instruments

Description & Manufacturer	Model No.	Serial No.	Cal. Date	Cal. Due
Test Receiver ROHDE & SCHWARZ (V)	ESR	101240	Oct. 30, 2018	Oct. 29, 2019
Test Receiver ROHDE & SCHWARZ (H)	ESR3	102412	Feb. 14, 2019	Feb. 13, 2020
BILOG Antenna SCHWARZBECK (V)	VULB9168	9168-148	Nov. 20, 2018	Nov. 19, 2019
BILOG Antenna SCHWARZBECK (H)	VULB9168	9168-156	Nov. 20, 2018	Nov. 19, 2019
Preamplifier Sonoma (V)	310N	352924	Jul. 12, 2018	Jul. 11, 2019
Preamplifier Sonoma (H)	310N	352923	Jul. 12, 2018	Jul. 11, 2019
RF signal cable (with 5dB PAD) Times (V)	LMR-600 (18M) +LMR-400 (7M)	CABLE-CH1 (VER) -01	Oct. 03, 2018	Oct. 02, 2019
RF signal cable (with 5dB PAD) Times (H)	LMR-600 (11.8M) +LMR-400 (7M)	CABLE-CH1 (HOR) -01	Oct. 03, 2018	Oct. 02, 2019
Software BV ADT	BV ADT_Radiated_ V8.7.08	NA	NA	NA
Antenna Tower (V)	MFA-440	9707	NA	NA
Antenna Tower (H)	MFA-440	970705	NA	NA
Turn Table	DS430	50303	NA	NA
Controller (V)	MF7802	074	NA	NA
Controller (H)	MF7802	08093	NA	NA

- NOTE: 1. The calibration interval of the above test instruments is 12 months and the calibrations are traceable to NML/ROC and NIST/USA.
2. The test was performed in HwaYa Chamber 1.
 3. The IC Site Registration No. is IC 7450F-1.
 4. The VCCI Site Registration No. is R-1893.

7.3 Test Arrangement

- The EUT was placed on the top of a rotating table 0.8 meters above the ground at an accredited test facility. The table was rotated 360 degrees to determine the position of the highest radiation.
- The EUT was set 10 meters away from the interference-receiving antenna, which was mounted on the top of a variable-height antenna tower.
- The antenna is a broadband antenna, and its height is varied from one meter to four meters above the ground to determine the maximum value of the field strength. Both horizontal and vertical polarizations of the antenna are set to make the measurement.
- For each suspected emission, the EUT was arranged to its worst case and then the antenna was tuned to heights from 1 meter to 4 meters and the rotatable table was turned from 0 degrees to 360 degrees to find the maximum reading.
- The test-receiver system was set to quasi-peak detect function and specified bandwidth with maximum hold mode when the test frequency is up to 1 GHz.

Note: The resolution bandwidth and video bandwidth of test receiver/spectrum analyzer is 120 kHz for quasi-peak detection (QP) at frequency up to 1 GHz.

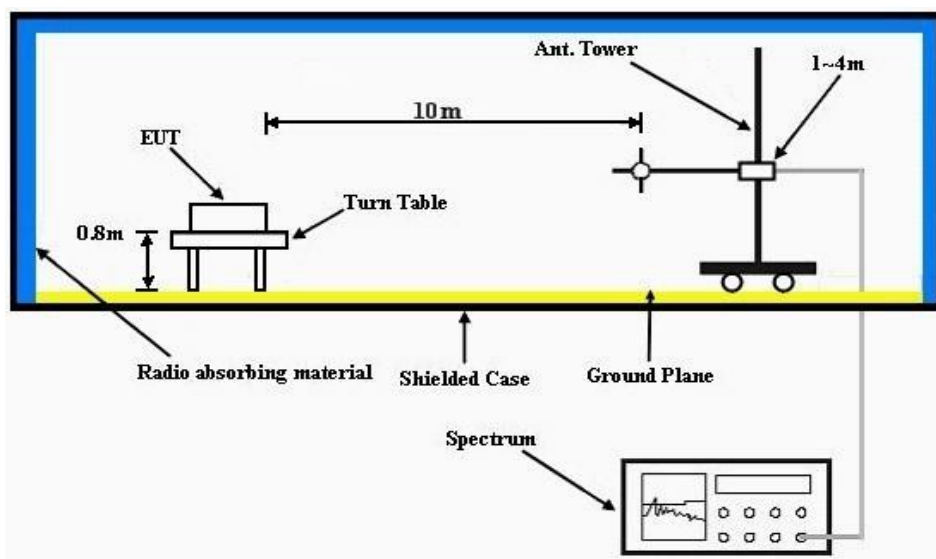

Note: According to EN 55032 standard, cables on the RGP must be insulated.

7.4 Test Results

Frequency Range	30MHz ~ 1GHz	Detector Function & Bandwidth	Quasi-Peak (QP), 120kHz
Test Mode	Mode 1	Environmental Conditions	22°C, 65%RH
Tested by	Jim Lee	Test Date	2019/3/18

Antenna Polarity & Test Distance : Horizontal at 10 m								
No	Frequency (MHz)	Emission Level (dBuV/m)	Limit (dBuV/m)	Margin (dB)	Antenna Height (m)	Table Angle (Degree)	Raw Value (dBuV)	Correction Factor (dB/m)
1	324.99	32.71 QP	47.00	-14.29	2.00 H	132	43.85	-11.14
2	375.00	39.51 QP	47.00	-7.49	1.00 H	266	50.80	-11.29
3	400.03	34.44 QP	47.00	-12.56	3.00 H	173	43.67	-9.23
4	624.98	34.56 QP	47.00	-12.44	4.00 H	98	39.07	-4.51
5	744.00	36.43 QP	47.00	-10.57	2.50 H	215	39.87	-3.44
6	792.02	35.69 QP	47.00	-11.31	1.00 H	298	37.22	-1.53
7	881.07	38.98 QP	47.00	-8.02	1.00 H	269	39.97	-0.99

Remarks:

1. Emission Level(dBuV/m) = Raw Value(dBuV) + Correction Factor(dB/m)
2. Correction Factor(dB/m) = Antenna Factor (dB/m) + Cable Factor (dB) – Pre-Amplifier Factor (dB)
3. The other emission levels were very low against the limit.
4. Margin value = Emission level – Limit value

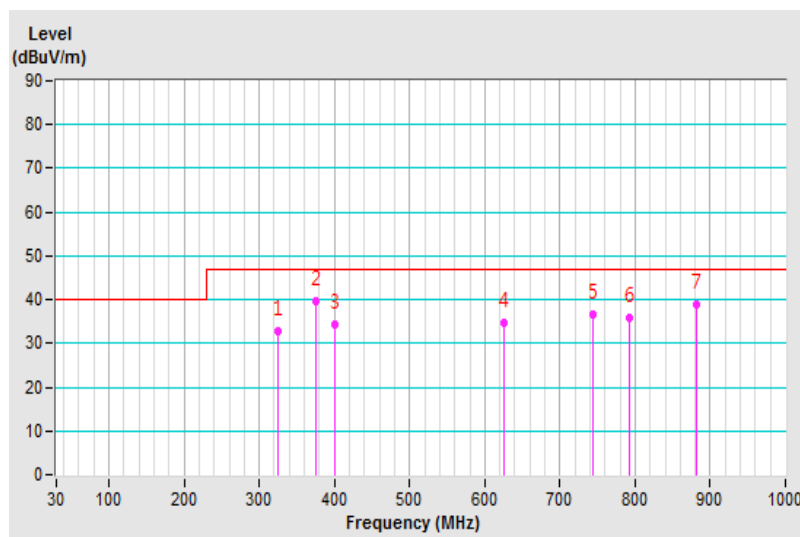

Frequency Range	30MHz ~ 1GHz	Detector Function & Bandwidth	Quasi-Peak (QP), 120kHz
Test Mode	Mode 1	Environmental Conditions	22°C, 65%RH
Tested by	Jim Lee	Test Date	2019/3/18

Antenna Polarity & Test Distance : Vertical at 10 m

No	Frequency (MHz)	Emission Level (dBuV/m)	Limit (dBuV/m)	Margin (dB)	Antenna Height (m)	Table Angle (Degree)	Raw Value (dBuV)	Correction Factor (dB/m)
1	34.61	36.44 QP	40.00	-3.56	1.00 V	344	51.57	-15.13
2	71.37	33.09 QP	40.00	-6.91	2.00 V	11	49.04	-15.95
3	121.96	34.26 QP	40.00	-5.74	3.00 V	87	50.03	-15.77
4	156.93	32.71 QP	40.00	-7.29	2.50 V	51	45.77	-13.06
5	180.12	32.51 QP	40.00	-7.49	2.00 V	279	46.63	-14.12
6	304.72	37.67 QP	47.00	-9.33	1.00 V	3	49.67	-12.00
7	351.57	38.83 QP	47.00	-8.17	1.00 V	325	49.68	-10.85
8	375.00	43.96 QP	47.00	-3.04	1.00 V	328	54.78	-10.82

Remarks:

1. Emission Level(dBuV/m) = Raw Value(dBuV) + Correction Factor(dB/m)
2. Correction Factor(dB/m) = Antenna Factor (dB/m) + Cable Factor (dB) – Pre-Amplifier Factor (dB)
3. The other emission levels were very low against the limit.
4. Margin value = Emission level – Limit value

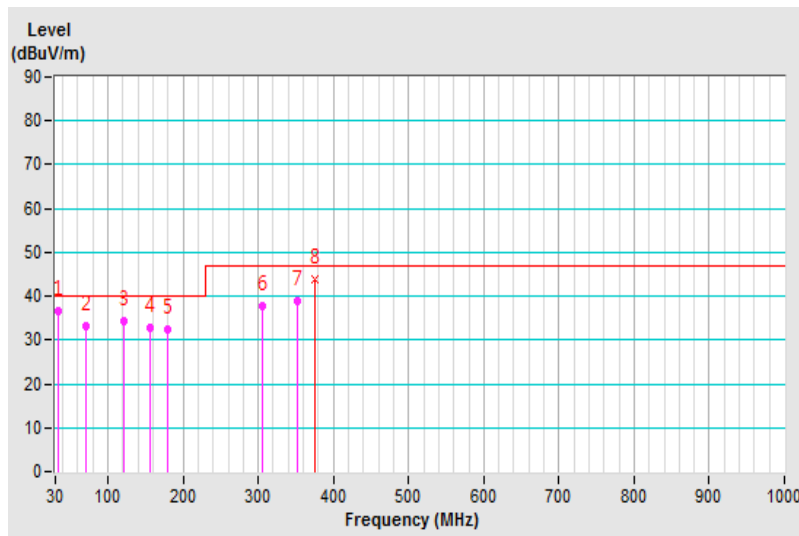

8 Radiated Disturbance above 1 GHz

8.1 Limits

Frequency (GHz)	Class A (dBuV/m) (at 3 m)		Class B (dBuV/m) (at 3 m)	
	Average	Peak	Average	Peak
1 to 3	56	76	50	70
3 to 6	60	80	54	74

Notes:

1. The lower limit shall apply at the transition frequencies.
2. Emission level (dBuV/m) = 20 log Emission level (uV/m).
3. All emanations from a class A/B digital device or system, including any network of conductors and apparatus connected thereto, shall not exceed the level of field strengths specified above.

Frequency Range (For unintentional radiators)

Highest frequency generated or used in the EUT or on which the EUT operates or tunes (MHz)	Upper frequency of measurement range (MHz)
Below 108	1000
108-500	2000
500-1000	5000
Above 1000	Up to 5 times of the highest frequency or 6 GHz, whichever is less

8.2 Test Instruments

Description & Manufacturer	Model No.	Serial No.	Cal. Date	Cal. Due
Test Receiver ROHDE & SCHWARZ (Above 1GHz)	ESR7	101471	Mar. 07, 2019	Mar. 06, 2020
Spectrum Analyzer Agilent	E4446A	MY51100039	Sep. 10, 2018	Sep. 09, 2019
RF signal cable (with 5dB PAD) Times	LMR-400 (18M)	CABLE-CH2-01	Apr. 27, 2018	Apr. 26, 2019
HORN Antenna (with 4dB PAD) SCHWARZBECK	BBHA 9120 D	9120D-405	Nov. 25, 2018	Nov. 24, 2019
Pre-Amplifier Agilent (Above 1GHz)	8449B	3008A01961	Oct. 15, 2018	Oct. 14, 2019
RF Coaxial Cable JUNFLON+EMC	JUNFLON+EMC10 4-SM-SM-6000	Cable-CH2-02(MWX3221308 G003+130710)	Jun. 11, 2018	Jun. 10, 2019
Software BV ADT	BV ADT_Radiated_ V8.7.08	NA	NA	NA
Antenna Tower BV ADT	AT100	AT93021702	NA	NA
Turn Table BV ADT	TT100	TT93021702	NA	NA
Controller BV ADT	SC100	SC93021702	NA	NA
BandPass Filter (2.4G) MICRO-TRONICS	BRM17690-01	003	Sep. 12, 2018	Sep. 11, 2019
BandPass Filter (5G) MICRO-TRONICS	BRM50716-01	G011	Sep. 12, 2018	Sep. 11, 2019

- Note: 1. The calibration interval of the above test instruments is 12 months and the calibrations are traceable to NML/ROC and NIST/USA.
2. The test was performed in HwaYa Chamber 2.
3. The horn antenna and preamplifier (model: 8449B) are used only for the measurement of emission frequency above 1GHz if tested.
4. The IC Site Registration No. is IC 7450F-2.
5. The VCCI Site Registration No. is G-10018.

8.3 Test Arrangement

- The EUT was placed on the top of a rotating table 0.8 meters above the ground at an accredited chamber room. The table was rotated 360 degrees to determine the position of the highest radiation.
- The EUT was set 3 meters away from the interference-receiving antenna, which was mounted on the top of a variable-height antenna tower.
- The height of antenna can be varied from one meter to four meters, the height of adjustment depends on the EUT height and the antenna 3 dB beamwidth both, to detect the maximum value of the field strength. Both horizontal and vertical polarizations of the antenna are set to make the measurement.
- For each suspected emission, the EUT was arranged to its worst case and then the antenna was tuned to heights and the rotatable table was turned from 0 degrees to 360 degrees to find the maximum reading.
- The spectrum analyzer system was set to peak and average detect function and specified bandwidth with maximum hold mode when the test frequency is above 1 GHz.

Note: The resolution bandwidth of test receiver/spectrum analyzer is 1 MHz and video bandwidth is 3 MHz for Peak detection (PK) at frequency above 1 GHz. The resolution bandwidth of test receiver/spectrum analyzer is 1 MHz for Average detection (AV) at frequency above 1 GHz.

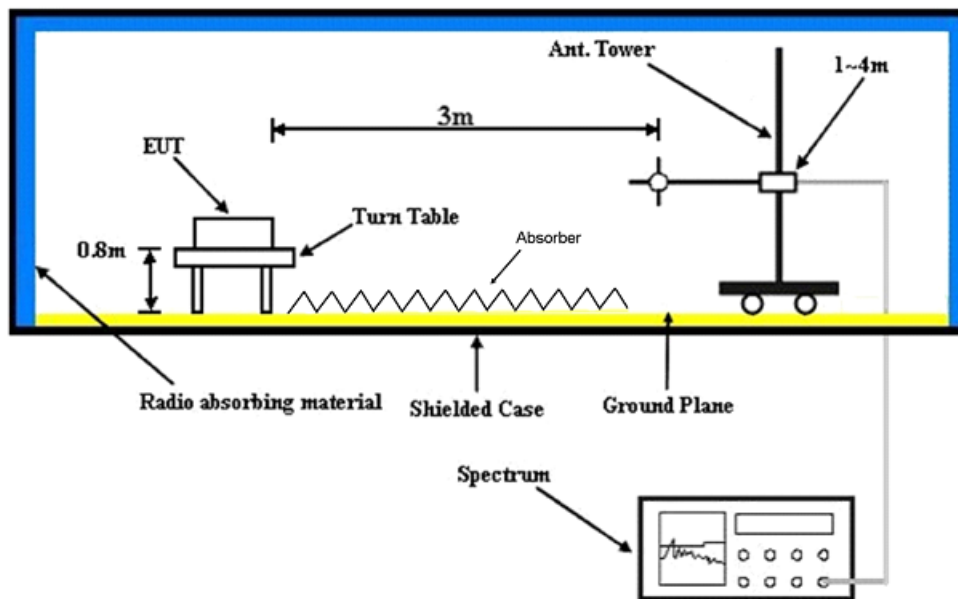

Note: According to EN 55032 standard, cables on the RGP must be insulated.

8.4 Test Results

Frequency Range	1GHz ~ 6GHz	Detector Function & Bandwidth	Peak (PK) / Average (AV), 1MHz
Test Mode	Mode 1	Environmental Conditions	20°C, 60%RH
Tested by	Pon Tsai	Test Date	2019/3/16

Antenna Polarity & Test Distance : Horizontal at 3 m

No	Frequency (MHz)	Emission Level (dBuV/m)	Limit (dBuV/m)	Margin (dB)	Antenna Height (m)	Table Angle (Degree)	Raw Value (dBuV)	Correction Factor (dB/m)
1	1063.93	48.61 PK	76.00	-27.39	1.00 H	181	52.70	-4.09
2	1063.93	36.18 AV	56.00	-19.82	1.00 H	181	40.27	-4.09
3	1417.01	55.65 PK	76.00	-20.35	1.49 H	199	57.03	-1.38
4	1417.01	39.51 AV	56.00	-16.49	1.49 H	199	40.89	-1.38
5	1946.25	57.68 PK	76.00	-18.32	2.00 H	13	57.52	0.16
6	1946.25	39.67 AV	56.00	-16.33	2.00 H	13	39.51	0.16
7	2415.13	57.61 PK	76.00	-18.39	1.00 H	360	54.86	2.75
8	2415.13	47.24 AV	56.00	-8.76	1.00 H	360	44.49	2.75
9	2587.52	53.33 PK	76.00	-22.67	1.00 H	352	50.52	2.81
10	2587.52	40.62 AV	56.00	-15.38	1.00 H	352	37.81	2.81
11	2890.40	58.02 PK	76.00	-17.98	2.50 H	230	54.18	3.84
12	2890.40	38.42 AV	56.00	-17.58	2.50 H	230	34.58	3.84

Remarks:

1. Emission Level(dBuV/m) = Raw Value(dBuV) + Correction Factor(dB/m)
2. Correction Factor(dB/m) = Antenna Factor (dB/m) + Cable Factor (dB) – Pre-Amplifier Factor (dB)
3. The other emission levels were very low against the limit.
4. Margin value = Emission level – Limit value

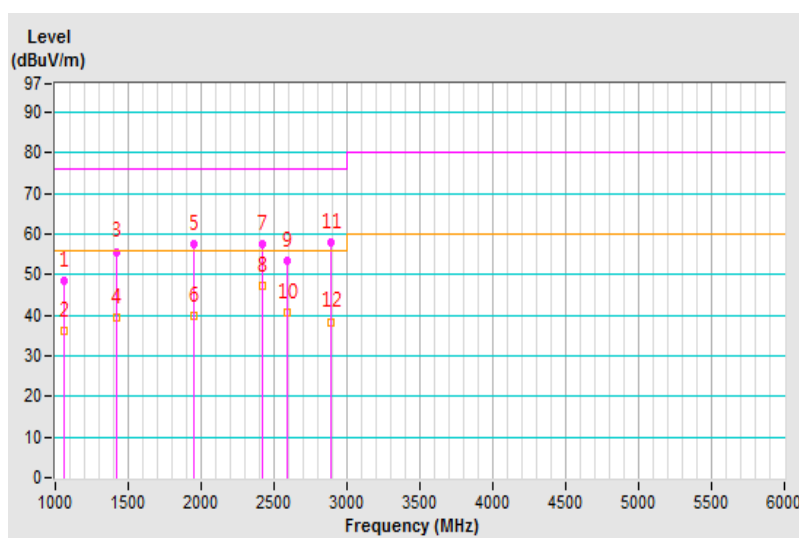

Frequency Range	1GHz ~ 6GHz	Detector Function & Bandwidth	Peak (PK) / Average (AV), 1MHz
Test Mode	Mode 1	Environmental Conditions	20°C, 60%RH
Tested by	Pon Tsai	Test Date	2019/3/16

Antenna Polarity & Test Distance : Vertical at 3 m

No	Frequency (MHz)	Emission Level (dBuV/m)	Limit (dBuV/m)	Margin (dB)	Antenna Height (m)	Table Angle (Degree)	Raw Value (dBuV)	Correction Factor (dB/m)
1	1414.00	55.04 PK	76.00	-20.96	1.00 V	0	56.40	-1.36
2	1414.00	39.76 AV	56.00	-16.24	1.00 V	0	41.12	-1.36
3	1520.53	52.88 PK	76.00	-23.12	3.00 V	30	54.52	-1.64
4	1520.53	38.85 AV	56.00	-17.15	3.00 V	30	40.49	-1.64
5	1951.22	59.03 PK	76.00	-16.97	1.00 V	207	58.85	0.18
6	1951.22	40.48 AV	56.00	-15.52	1.00 V	207	40.30	0.18
7	2414.99	57.89 PK	76.00	-18.11	3.00 V	325	55.14	2.75
8	2414.99	49.75 AV	56.00	-6.25	3.00 V	325	47.00	2.75
9	2890.33	56.41 PK	76.00	-19.59	1.99 V	133	52.57	3.84
10	2890.33	38.10 AV	56.00	-17.90	1.99 V	133	34.26	3.84
11	5000.00	52.20 PK	80.00	-27.80	1.00 V	7	42.58	9.62
12	5000.00	42.51 AV	60.00	-17.49	1.00 V	7	32.89	9.62

Remarks:

1. Emission Level(dBuV/m) = Raw Value(dBuV) + Correction Factor(dB/m)
2. Correction Factor(dB/m) = Antenna Factor (dB/m) + Cable Factor (dB) – Pre-Amplifier Factor (dB)
3. The other emission levels were very low against the limit.
4. Margin value = Emission level – Limit value

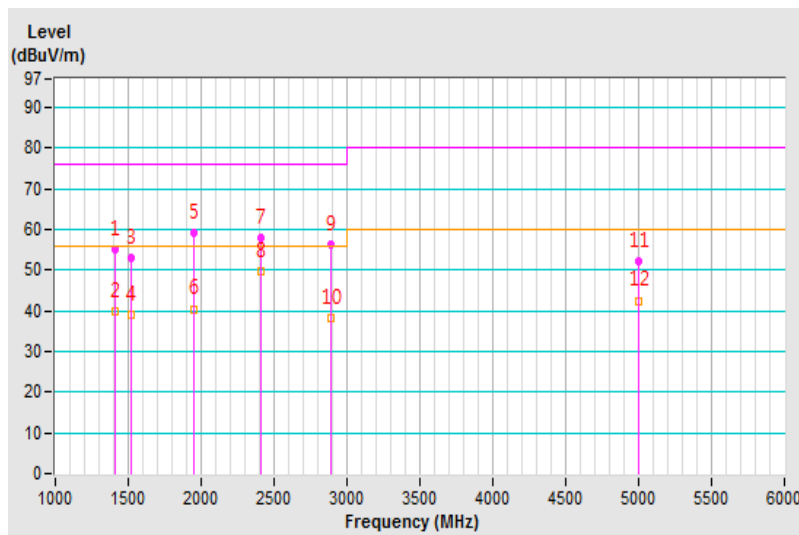

9 Harmonics Current Measurement

9.1 Limits

Limits for Class A equipment		Limits for Class D equipment		
Harmonic Order n	Max. permissible harmonics current A	Harmonic Order n	Max. permissible harmonics current per watt mA/W	Max. permissible harmonics current A
Odd harmonics		Odd Harmonics only		
3	2.30	3	3.4	2.30
5	1.14	5	1.9	1.14
7	0.77	7	1.0	0.77
9	0.40	9	0.5	0.40
11	0.33	11	0.35	0.33
13	0.21	13	0.30	0.21
$15 \leq n \leq 39$	$0.15 \times 15/n$	$15 \leq n \leq 39$	$3.85/n$	$0.15 \times 15/n$
Even harmonics				
2	1.08			
4	0.43			
6	0.30			
$8 \leq n \leq 40$	$0.23 \times 8/n$			

Notes:

1. Class A and Class D are classified according to section 5 of EN 61000-3-2.
2. According to section 7 of EN 61000-3-2, the above limits for all equipment except for lighting equipment having an active input power > 75 W and no limits apply for equipment with an active input power up to and including 75 W.

9.2 Classification of Equipment

The EUT is Class A in accordance with EN 61000-3-2 as follows:

Class A	Class B	Class C	Class D
Balanced three-phase equipment, Household appliances excluding equipment as Class D, Tools excluding portable tools, Dimmers for incandescent lamps, audio equipment, equipment not specified in one of the three other classes.	Portable tools.; Arc welding equipment which is not professional equipment	Lighting equipment.	Equipment having a specified power less than or equal to 600 W of the following types: Personal computers and personal computer monitors; Television receivers; Refrigerators and freezers having one or more variable-speed drives to control compressor motor(s).

9.3 Test Instruments

Description & Manufacturer	Model No.	Serial No.	Cal. Date	Cal. Due
Schaffner AC Power Source	NSG1007	55616	Oct. 15, 2018	Oct. 14, 2019
Schaffner Signal Conditioning Unit- Lumped Impedance	CCN1000-1-LR1	72224	Oct. 15, 2018	Oct. 14, 2019
Software	CTS 4	NA	NA	NA

Notes: 1. The test was performed in Hwa Ya EMS Room 2.

2. The calibration interval of the above test instruments is 12 months and the calibrations are traceable to NML/ROC and NIST/USA.

9.4 Test Arrangement

- The EUT was placed on the top of a wooden table 0.8 meters above the ground and operated to produce the maximum harmonic components under normal operating conditions for each successive harmonic component in turn.
- The correspondent test program of test instrument to measure the current harmonics emanated from EUT is chosen. The measure time shall be not less than the time necessary for the EUT to be exercised.

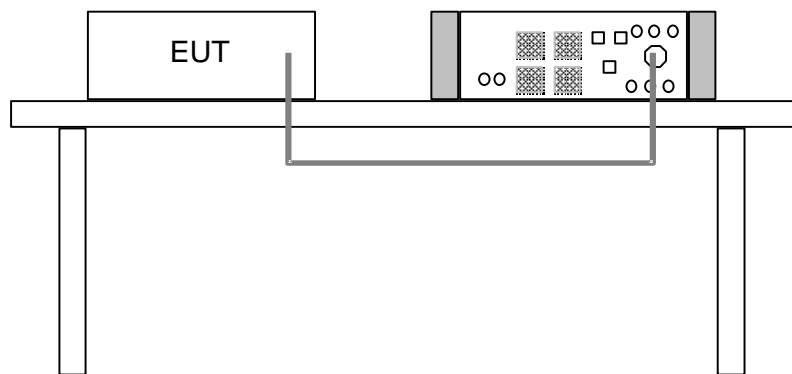

9.5 Test Results

Test Duration (mins)	3	Tested by	Howard Yang
Fundamental Voltage/Ampere	230.17 Vrms/ 0.622 Arms	Power Frequency	50 Hz
Power Consumption	126.6 W	Power Factor	0.910
Environmental Conditions	22 °C, 55 % RH	Test Date	2019/02/25
Test Mode	1		

Note: 1. Limits are not specified for equipment with a rated power of 75 W or less (other than lighting equipment).

2. According to EN 61000-3-2 the manufacturer shall specify the power of the apparatus. This value shall be used for establishing limits. The specified power shall be within +/-10 % of the measured power.

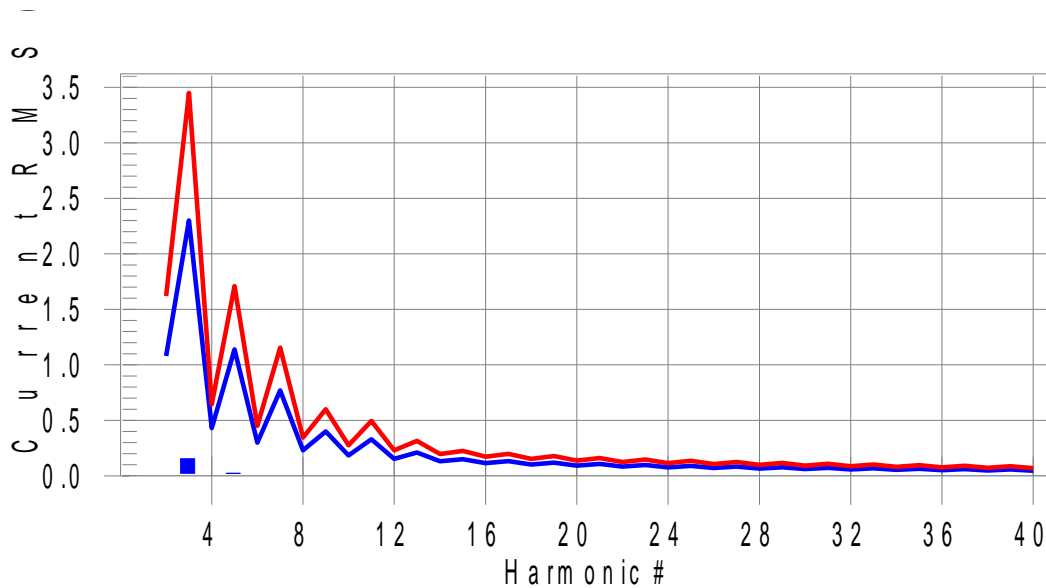

Harm #	Harms (avg) (A)	100% Limit (A)	Harms (max) (A)	150% Limit (A)	Test Result
2	0.002	1.08	0.002	1.62	Pass
3	0.154	2.3	0.157	3.45	Pass
4	0.001	0.43	0.001	0.645	Pass
5	0.023	1.14	0.026	1.71	Pass
6	0.001	0.3	0.001	0.45	Pass
7	0.015	0.77	0.017	1.155	Pass
8	0.001	0.23	0.001	0.345	Pass
9	0.018	0.4	0.019	0.6	Pass
11	0.002	0.33	0.002	0.495	Pass
13	0.004	0.21	0.006	0.315	Pass
15	0.005	0.15	0.006	0.225	Pass
17	0.003	0.132	0.003	0.198	Pass
19	0.005	0.118	0.006	0.178	Pass
21	0.003	0.107	0.004	0.161	Pass
23	0.004	0.098	0.005	0.147	Pass
25	0.001	0.09	0.002	0.135	Pass
27	0.002	0.083	0.003	0.125	Pass
28	0.001	0.066	0.001	0.099	Pass
29	0.001	0.078	0.002	0.116	Pass
30	0.001	0.061	0.001	0.092	Pass
31	0.003	0.073	0.004	0.109	Pass
32	0.001	0.058	0.001	0.086	Pass
33	0.003	0.068	0.005	0.102	Pass
34	0.001	0.054	0.001	0.081	Pass
35	0.004	0.064	0.006	0.096	Pass
36	0.001	0.051	0.001	0.077	Pass
37	0.002	0.061	0.004	0.091	Pass
38	0.001	0.048	0.001	0.073	Pass
39	0.004	0.058	0.005	0.087	Pass
40	0.001	0.046	0.001	0.069	Pass

Note: Dynamic limits were applied for this test. The highest harmonics values in the above table may not occur at the same window as the maximum harmonics/limit ratio.

Test Duration (mins)	3	Tested by	Howard Yang
Fundamental Voltage/Ampere	230.17 Vrms/ 0.622 Arms	Power Frequency	50 Hz
Power Consumption	126.7 W	Power Factor	0.909
Environmental Conditions	22 °C, 55 % RH	Test Date	2019/02/25
Test Mode	2		

- Note: 1. Limits are not specified for equipment with a rated power of 75 W or less (other than lighting equipment).
2. According to EN 61000-3-2 the manufacturer shall specify the power of the apparatus. This value shall be used for establishing limits. The specified power shall be within +/-10 % of the measured power.

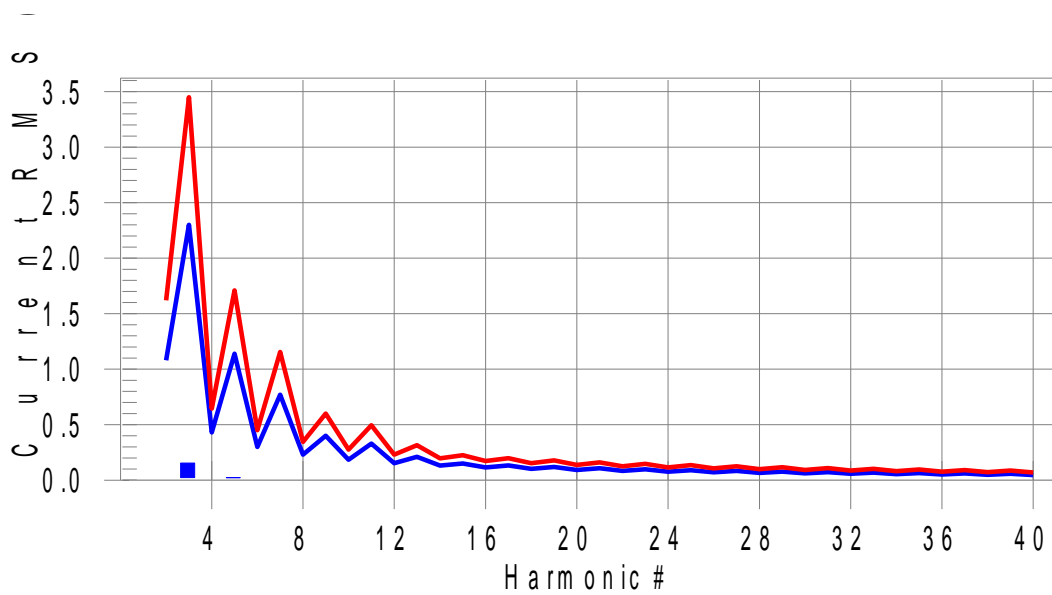

Harm #	Harms (avg) (A)	100% Limit (A)	Harms (max) (A)	150% Limit (A)	Test Result
2	0.002	N/A	0.003	N/A	Pass
3	0.154	6.7	0.157	4.6	Pass
4	0.001	N/A	0.001	N/A	Pass
5	0.024	2.1	0.027	1.6	Pass
6	0.001	N/A	0.001	N/A	Pass
7	0.015	1.9	0.017	1.5	Pass
8	0.001	N/A	0.001	N/A	Pass
9	0.018	4.5	0.019	3.1	Pass
11	0.002	N/A	0.002	N/A	Pass
13	0.004	N/A	0.007	N/A	Pass
15	0.005	N/A	0.006	N/A	Pass
17	0.003	N/A	0.004	N/A	Pass
19	0.005	4.4	0.006	3.3	Pass
20	0.001	N/A	0.001	N/A	Pass
21	0.003	N/A	0.005	N/A	Pass
23	0.004	N/A	0.004	N/A	Pass
25	0.001	N/A	0.002	N/A	Pass
26	0.001	N/A	0.001	N/A	Pass
27	0.002	N/A	0.003	N/A	Pass
28	0.001	N/A	0.001	N/A	Pass
29	0.001	N/A	0.002	N/A	Pass
30	0.001	N/A	0.001	N/A	Pass
31	0.003	N/A	0.004	N/A	Pass
32	0.001	N/A	0.001	N/A	Pass
33	0.003	N/A	0.005	N/A	Pass
34	0.001	N/A	0.001	N/A	Pass
35	0.004	N/A	0.005	N/A	Pass
36	0.001	N/A	0.001	N/A	Pass
37	0.002	N/A	0.004	N/A	Pass
38	0.001	N/A	0.001	N/A	Pass
39	0.003	N/A	0.005	N/A	Pass
40	0.001	N/A	0.001	N/A	Pass

Note: Dynamic limits were applied for this test. The highest harmonics values in the above table may not occur at the same window as the maximum harmonics/limit ratio.

Test Duration (mins)	3	Tested by	Howard Yang
Fundamental Voltage/Ampere	230.18 Vrms/ 0.521 Arms	Power Frequency	50 Hz
Power Consumption	101.1 W	Power Factor	0.876
Environmental Conditions	22 °C, 55 % RH	Test Date	2019/02/25
Test Mode	3		

- Note: 1. Limits are not specified for equipment with a rated power of 75 W or less (other than lighting equipment).
2. According to EN 61000-3-2 the manufacturer shall specify the power of the apparatus. This value shall be used for establishing limits. The specified power shall be within +/-10 % of the measured power.

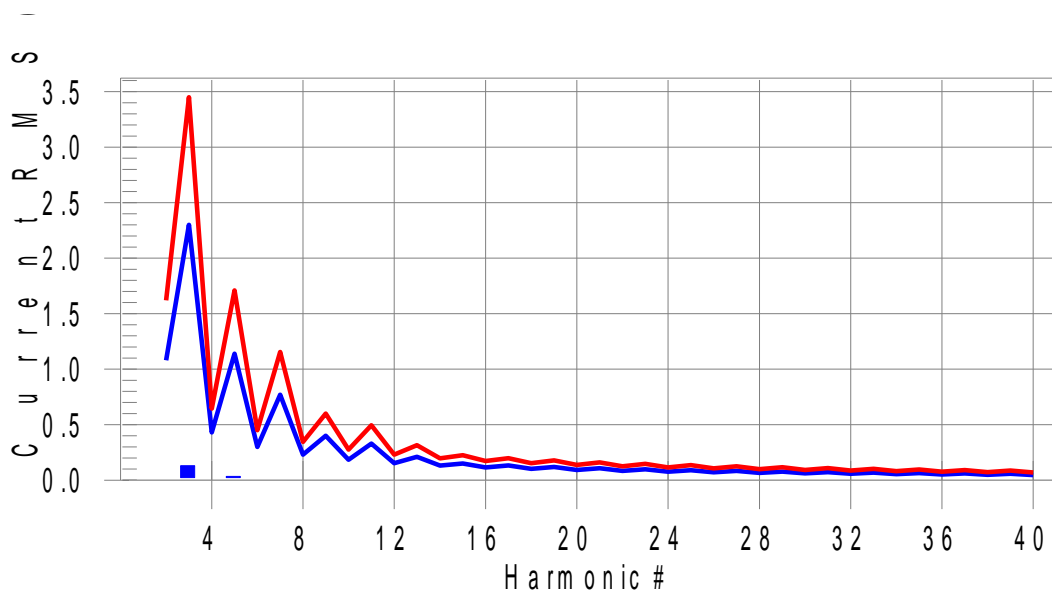

Harm #	Harms (avg) (A)	100% Limit (A)	Harms (max) (A)	150% Limit (A)	Test Result
2	0.002	N/A	0.002	N/A	Pass
3	0.129	5.6	0.14	4.1	Pass
4	0.001	N/A	0.001	N/A	Pass
5	0.034	2.9	0.034	2	Pass
7	0.014	1.9	0.015	1.3	Pass
9	0.006	1.6	0.013	2.2	Pass
11	0.004	N/A	0.006	N/A	Pass
13	0.007	3.4	0.009	2.7	Pass
15	0.004	N/A	0.004	N/A	Pass
17	0.004	N/A	0.004	N/A	Pass
19	0.005	4.5	0.006	3.4	Pass
21	0.001	N/A	0.005	N/A	Pass
23	0.002	N/A	0.003	N/A	Pass
25	0.002	N/A	0.003	N/A	Pass
27	0.003	N/A	0.004	N/A	Pass
28	0.001	N/A	0.001	N/A	Pass
29	0.003	N/A	0.004	N/A	Pass
30	0.001	N/A	0.001	N/A	Pass
31	0.004	N/A	0.006	N/A	Pass
32	0.001	N/A	0.001	N/A	Pass
33	0.003	N/A	0.005	N/A	Pass
34	0.001	N/A	0.001	N/A	Pass
35	0.004	N/A	0.005	N/A	Pass
36	0.001	N/A	0.001	N/A	Pass
37	0.002	N/A	0.005	N/A	Pass
38	0.001	N/A	0.001	N/A	Pass
39	0.002	N/A	0.004	N/A	Pass
40	0.001	N/A	0.001	N/A	Pass

Note: Dynamic limits were applied for this test. The highest harmonics values in the above table may not occur at the same window as the maximum harmonics/limit ratio.

10 Voltage Fluctuations and Flicker Measurement

10.1 Limits

Test item	Limit	Note
P_{st}	1.0	P_{st} : short-term flicker severity.
P_{lt}	0.65	P_{lt} : long-term flicker severity.
T_{max} (ms)	500	T_{max} : maximum time duration during the observation period that the voltage deviation $d(t)$ exceeds the limit for d_c .
d_{max} (%)	4	d_{max} : maximum absolute voltage change during an observation period.
d_c (%)	3.3	d_c : maximum steady state voltage change during an observation period.

10.2 Test Instruments

Description & Manufacturer	Model No.	Serial No.	Cal. Date	Cal. Due
Schaffner AC Power Source	NSG1007	55616	Oct. 15, 2018	Oct. 14, 2019
Schaffner Signal Conditioning Unit- Lumped Impedance	CCN1000-1-LR1	72224	Oct. 15, 2018	Oct. 14, 2019
Software	CTS 4	NA	NA	NA

Notes: 1. The test was performed in Hwa Ya EMS Room 2.

2. The calibration interval of the above test instruments is 12 months and the calibrations are traceable to NML/ROC and NIST/USA.

10.3 Test Arrangement

- The EUT was placed on the top of a wooden table 0.8 meters above the ground and operated to produce the most unfavorable sequence of voltage changes under normal operating conditions.
- During the flick measurement, the measure time shall include that part of whole operation cycle in which the EUT produce the most unfavorable sequence of voltage changes. The observation period for short-term flicker indicator is 10 minutes and the observation period for long-term flicker indicator is 2 hours.

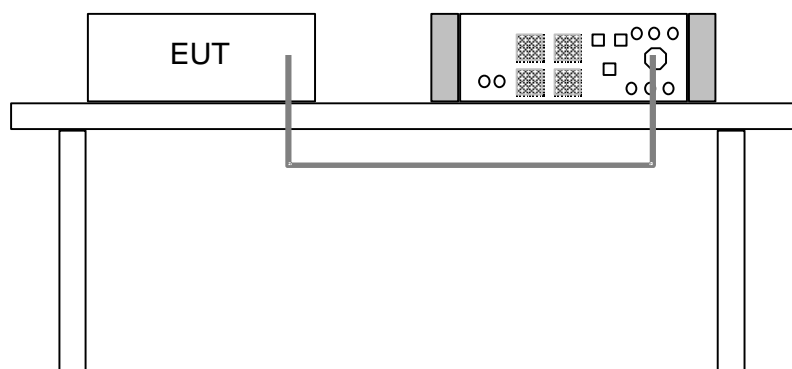

10.4 Test Results

Observation (T _p)	10 min.	Tested by	Howard Yang
Fundamental Voltage/Ampere	229.92 Vrms / 0.622 Arms	Power Frequency	50 Hz
Power Consumption	126.6 W	Power Factor	0.910
Environmental Conditions	22 °C, 55 % RH	Test Date	2019/02/25
Test Mode	1		

Test Parameter	Measurement Value	Limit	Remarks
P _{st}	0.064	1.00	Pass
P _{lt}	0.028	0.65	Pass
T _{max} (ms)	0	500	Pass
d _{max} (%)	0	4	Pass
d _c (%)	0	3.3	Pass

- Note: (1) P_{st} means short-term flicker indicator.
 (2) P_{lt} means long-term flicker indicator.
 (3) T_{max} means accumulated time value of d(t) with a deviation exceeding 3.3 %.
 (4) d_{max} means maximum relative voltage change.
 (5) d_c means maximum relative steady-state voltage change.

Observation (T _p)	10 min.	Tested by	Howard Yang
Fundamental Voltage/Ampere	229.90 Vrms / 0.622 Arms	Power Frequency	50 Hz
Power Consumption	126.7 W	Power Factor	0.909
Environmental Conditions	22 °C, 55 % RH	Test Date	2019/02/25
Test Mode	2		

Test Parameter	Measurement Value	Limit	Remarks
P _{st}	0.064	1.00	Pass
P _{lt}	0.028	0.65	Pass
T _{max} (ms)	0	500	Pass
d _{max} (%)	0	4	Pass
d _c (%)	0	3.3	Pass

- Note: (1) P_{st} means short-term flicker indicator.
 (2) P_{lt} means long-term flicker indicator.
 (3) T_{max} means accumulated time value of d(t) with a deviation exceeding 3.3 %.
 (4) d_{max} means maximum relative voltage change.
 (5) d_c means maximum relative steady-state voltage change.

Observation (T_p)	10 min.	Tested by	Howard Yang
Fundamental Voltage/Ampere	229.98 Vrms / 0.521 Arms	Power Frequency	50 Hz
Power Consumption	101.1 W	Power Factor	0.876
Environmental Conditions	22 °C, 55 % RH	Test Date	2019/02/25
Test Mode	3		

Test Parameter	Measurement Value	Limit	Remarks
P_{st}	0.064	1.00	Pass
P_{lt}	0.028	0.65	Pass
T_{max} (ms)	0	500	Pass
d_{max} (%)	0	4	Pass
d_c (%)	0	3.3	Pass

- Note: (1) P_{st} means short-term flicker indicator.
 (2) P_{lt} means long-term flicker indicator.
 (3) T_{max} means accumulated time value of $d(t)$ with a deviation exceeding 3.3 %.
 (4) d_{max} means maximum relative voltage change.
 (5) d_c means maximum relative steady-state voltage change.

11 General Immunity Requirements

EN 55024:2010, Immunity requirements				
Clause	Reference standard	Table	Test specification	Performance Criterion
4.2.1	EN 61000-4-2 ESD	1.3	Enclosure port: ±8 kV Air discharge, ±4 kV Contact discharge	B
4.2.3.2	EN 61000-4-3 RS	1.2	Enclosure port: 80-1000 MHz, 3 V/m, 80% AM (1 kHz)	A
4.2.2	EN 61000-4-4 EFT	.3	Signal ports and telecommunication ports: xDSL equipment: ±0.5 kV, 5/50 (T _r /T _h) ns, 100 kHz others: ±0.5 kV, 5/50 (T _r /T _h) ns, 5 kHz	B
		3.3	Input DC power port: ±0.5 kV, 5/50 (T _r /T _h) ns, 5 kHz	
		4.5	Input AC Power ports: ±1 kV, 5/50 (T _r /T _h) ns, 5 kHz	
4.2.5	EN 61000-4-5 Surge	2.2	Signal and telecommunication ports (direct to outdoor cables): 10/700 (5/320) (T _r /T _h) μs w/o primary protectors: ±1 kV, or with primary protectors fitted: ±4 kV	B
		3.2	Input DC power port (direct to outdoor cables): 1.2/50 (8/20) (T _r /T _h) μs Line to earth: ±0.5 kV	
		4.4	Input AC Power ports: 1.2/50 (8/20) (T _r /T _h) μs, Line to line: ±1 kV Line to earth: ±2 kV	
4.2.3.3	EN 61000-4-6 CS	2.1	Signal and telecommunication ports (cable length > 3 m): 0.15-80 MHz, 3 V, 80 % AM (1 kHz)	A
		3.1	Input DC power port: 0.15-80 MHz, 3 V, 80 % AM (1 kHz)	
		4.1	Input AC Power ports: 0.15-80 MHz, 3 V, 80 % AM (1 kHz)	
4.2.4	EN 61000-4-8 PFMF	1.1	Enclosure port: 50 or 60 Hz, 1 A/m	A
4.2.6	EN 61000-4-11 Dips & Interruptions	4.2	Input AC Power ports: Voltage Dips: >95 % reduction – 0.5 period 30 % reduction – 25 periods	B C
		4.3	Input AC Power ports: Voltage Interruptions: >95 % reduction – 250 periods	C

11.1 Specific Immunity Requirements by Manufacturer

N/A

11.2 Performance Criteria

General Performance Criteria

Performance criterion A

The equipment shall continue to operate as intended without operator intervention. No degradation of performance or loss of function is allowed below a performance level specified by the manufacturer when the equipment is used as intended. The performance level may be replaced by a permissible loss of performance. If the minimum performance level or the permissible performance loss is not specified by the manufacturer, then either of these may be derived from the product description and documentation, and by what the user may reasonably expect from the equipment if used as intended.

Performance criterion B

After the test, the equipment shall continue to operate as intended without operator intervention. No degradation of performance or loss of function is allowed, after the application of the phenomena below a performance level specified by the manufacturer, when the equipment is used as intended. The performance level may be replaced by a permissible loss of performance. During the test, degradation of performance is allowed. However, no change of operating state or stored data is allowed to persist after the test. If the minimum performance level (or the permissible performance loss) is not specified by the manufacturer, then either of these may be derived from the product description and documentation, and by what the user may reasonably expect from the equipment if used as intended.

Performance criterion C

Loss of function is allowed, provided the function is self-recoverable, or can be restored by the operation of the controls by the user in accordance with the manufacturer's instructions. Functions, and/or information stored in non-volatile memory, or protected by a battery backup, shall not be lost.

Product Specific Performance Criteria

The particular performance criteria which are specified in the normative annexes of EN 55024 take precedence over the corresponding parts of the general performance criteria.

Where particular performance criteria for specific functions are not given, then the general performance criteria shall apply.

Function	Performance criteria A	Performance criteria B	Performance criteria C
Read, write and storage of data	During the test storage devices shall maintain normal operation both in read/write and in standby conditions.	During and after the test failures which can be recovered by read and write retries are permissible (temporary delay in processing caused by this process is acceptable). Normal operation of the EUT shall be restored after the test, self-recovery to the conditions immediately prior to the application of the test is accepted where this is a normal means of recovery. In these cases, operator response is permitted to re-initialise an operation.	Failures during test that result in a delay in processing or a system abort, which after testing can be recovered to normal operation by reset or reboot, are permissible.
Data display	During the test, when seen from the normal viewing distance, the EUT shall operate with no change beyond the manufacturer's specification, in flicker, colour, focus and jitter (except for the power frequency magnetic field test).	Screen disturbances during the application of the test are permissible if they self-recover after removal of the external disturbance.	Failures during the test that cannot self-recover after removal of the external disturbance, but which can be recovered after the test to normal operation by reset or reboot are permissible.
Data input	During testing unintended input from an input device is not allowed. During testing input devices shall maintain the specified quality image data.	During testing keyboard/mouse "lock up" is not allowed. For EUT with manually inputted data that can be confirmed by reading the display, errors are permissible during testing if they can be recognised by the operator and easily corrected.	Failures during test that result in a delay in processing or a system abort, which after testing can be recovered to normal operation by reset or reboot, are permissible.
Data printing	During testing printers shall maintain the specified printing quality and normal operation.	During testing no degradation of the printing quality beyond the manufacturer's specification (such as distortion of character(s) or missing pixels) is permissible. A paper feed failure is allowed if after removal of the jammed sheets the job is automatically recovered and there is no loss of printed information.	During testing printing errors or omission of character(s) which require reprinting are permissible. Input/output failures that occur during testing that can be recovered to normal operation after testing by reset or reboot are also permissible.
Data processing	During testing failures which do not influence the specified operation within the product specification, and which do not prevent automatic recovery are permissible.	During testing failures which are recovered automatically but cause temporary delay in processing are permissible.	Failures during testing that - result in a delay in processing after the external disturbance is removed, but which can be recovered after testing to normal operation by a reset or reboot - result in a system abort, which can be recovered to normal operation after testing by reset or reboot, - are followed by alarms and can be recovered to normal operation by the operator's intervention after testing are permissible.

12 Electrostatic Discharge Immunity Test (ESD)

12.1 Test Specification

Basic Standard:	EN/IEC 61000-4-2
Discharge Impedance:	330 ohm / 150 pF
Discharge Voltage:	Air Discharge: $\pm 2, \pm 4, \pm 8$ kV (Direct) Contact Discharge: $\pm 2, \pm 4$ kV (Direct/Indirect)
Number of Discharge:	Air – Direct: 10 discharges per location (each polarity) Contact – Direct & Indirect: 25 discharges per location (each polarity) and min. 200 times in total
Discharge Mode:	Single Discharge
Discharge Period:	1-second minimum

12.2 Test Instruments

Description & Manufacturer	Model No.	Serial No.	Cal. Date	Cal. Due
EM Test ESD Generator	Dito//DM-150/330//D M-150/330-rfci	P1315117252	Jul. 31, 2018	Jul. 30, 2019

- Notes: 1. The test was performed in Hwa Ya ESD Room 3.
2. The calibration interval of the above test instruments is 12 months and the calibrations are traceable to NML/ROC and NIST/USA.

12.3 Test Arrangement

The discharges shall be applied in two ways:

- a. Contact discharges to the conductive surfaces and coupling planes:
The EUT shall be exposed to at least 200 discharges, 100 each at negative and positive polarity, at a minimum of four test points. One of the test points shall be subjected to at least 50 indirect discharges to the center of the front edge of the horizontal coupling plane. The remaining three test points shall each receive at least 50 direct contact discharges. If no direct contact test points are available, then at least 200 indirect discharges shall be applied in the indirect mode. Test shall be performed at a maximum repetition rate of one discharge per second.
- b. Air discharges at slots and apertures and insulating surfaces:
On those parts of the EUT where it is not possible to perform contact discharge testing, the equipment should be investigated to identify user accessible points where breakdown may occur. Such points are tested using the air discharge method. This investigation should be restricted to those area normally handled by the user. A minimum of 10 single air discharges shall be applied to the selected test point for each such area.

The basic test procedure was in accordance with EN/IEC 61000-4-2:

- a. Electrostatic discharges were applied only to those points and surfaces of the EUT that are accessible to users during normal operation.
- b. The test was performed with at least ten single discharges on the pre-selected points in the most sensitive polarity.
- c. The time interval between two successive single discharges was at least 1 second.
- d. The ESD generator was held perpendicularly to the surface to which the discharge was applied and the return cable was at least 0.2 meters from the EUT.
- e. Contact discharges were applied to the non-insulating coating, with the pointed tip of the generator penetrating the coating and contacting the conducting substrate.
- f. Air discharges were applied with the round discharge tip of the discharge electrode approaching the EUT as fast as possible (without causing mechanical damage) to touch the EUT. After each discharge, the ESD generator was removed from the EUT and re-triggered for a new single discharge. The test was repeated until all discharges were complete.
- g. At least ten single discharges (in the most sensitive polarity) were applied to the Horizontal Coupling Plane at points on each side of the EUT. The ESD generator was positioned at a distance of 0.1 meters from the EUT with the discharge electrode touching the HCP.
- h. At least ten single discharges (in the most sensitive polarity) were applied to the center of one vertical edge of the Vertical Coupling Plane in sufficiently different positions that the four faces of the EUT were completely illuminated. The VCP (dimensions 0.5 m x 0.5 m) was placed vertically to and 0.1 meters from the EUT.

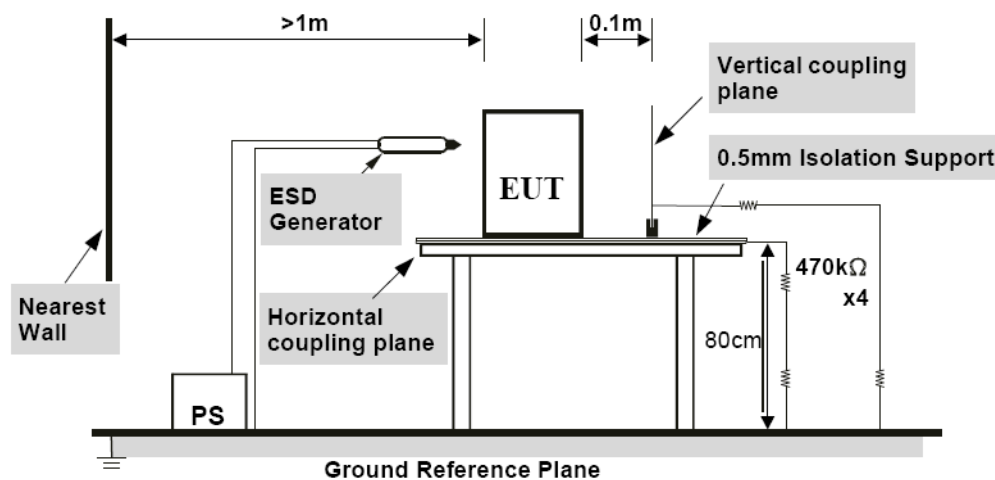

12.4 Test Results

Input Power	230 Vac, 50 Hz	Tested by	Evan Liao
Environmental Conditions	23 °C, 40 % RH 988 mbar	Test Date	2019/03/26
Test Mode	1		

Test Results of Direct Application					
Discharge Level (kV)	Polarity (+/-)	Test Point	Contact Discharge	Air Discharge	Performance Criterion
2, 4, 8	+/-	10-12	NA	Note 1	A
2, 4	+/-	1-9	Note 1	NA	A

Description of test points of direct application: Please refer to following page for representative mark only.

Test Results of Indirect Application					
Discharge Level (kV)	Polarity (+/-)	Test Point	Horizontal Coupling Plane	Vertical Coupling Plane	Performance Criterion
2, 4	+/-	Four Sides	Note 1	Note 1	A

Description of test points of indirect application:

1. Front side 2. Rear side 3. Right side 4. Left side

Note: 1. The EUT function was correct during the test.

Description of Test Points

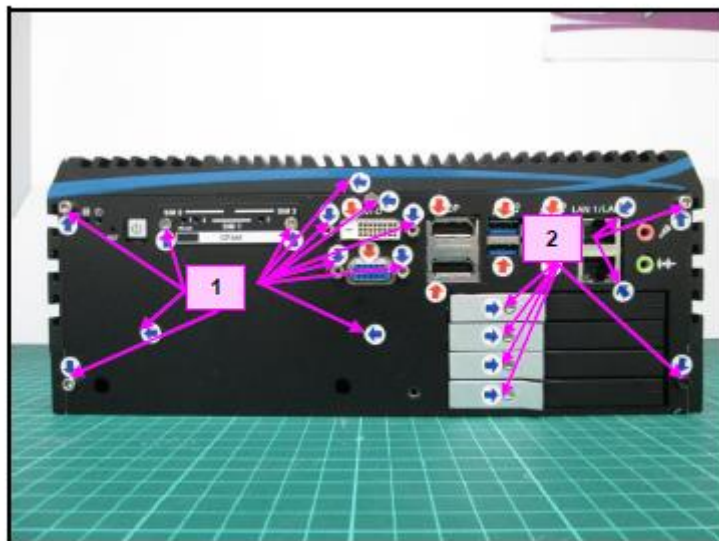
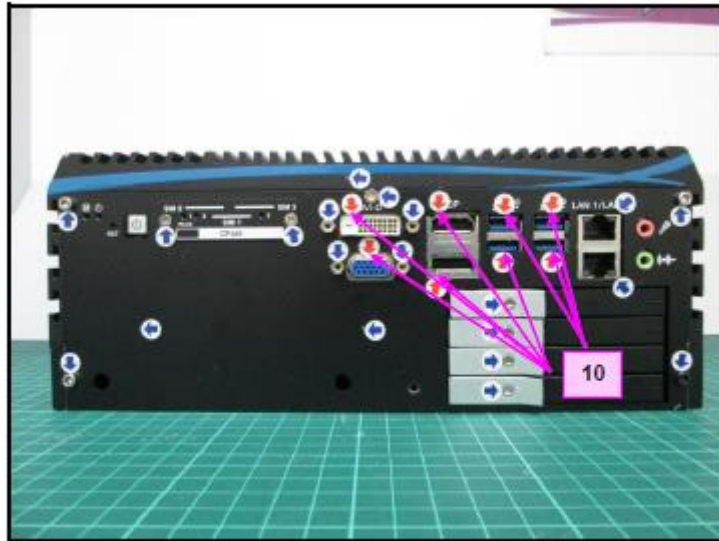

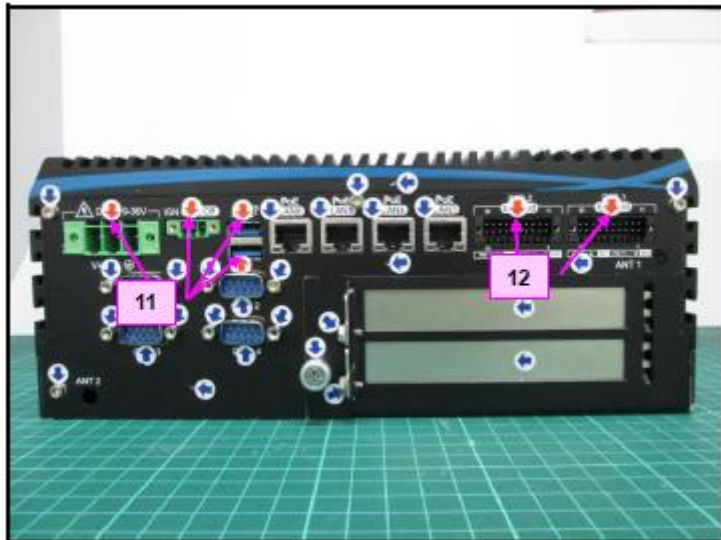

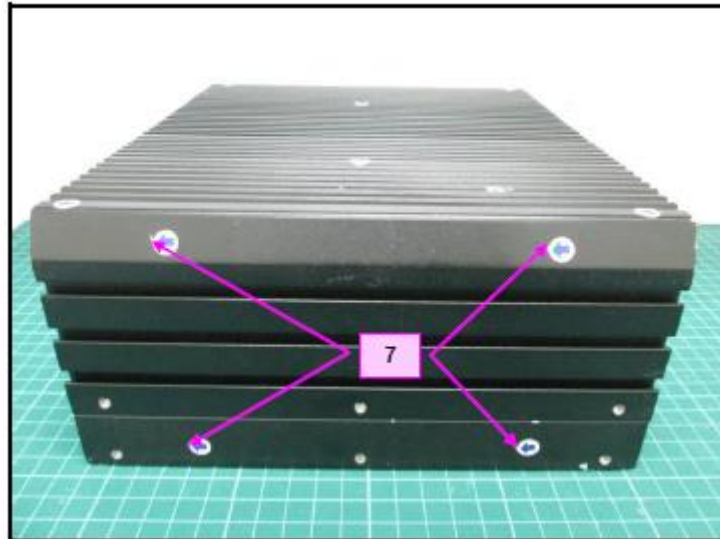
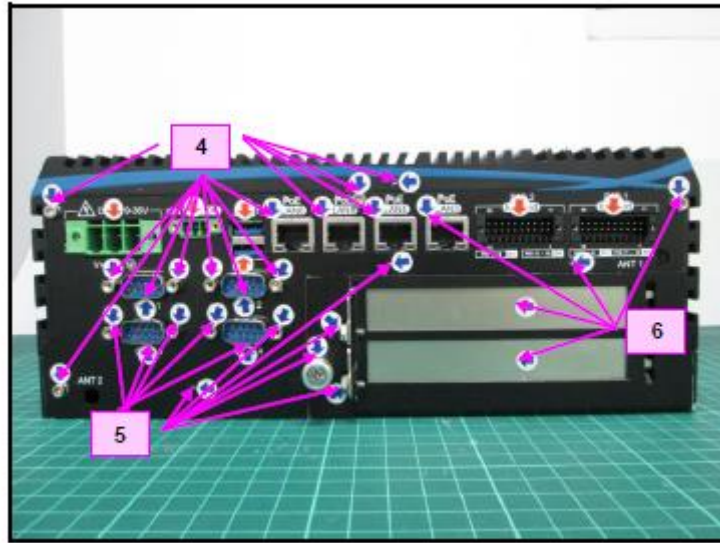

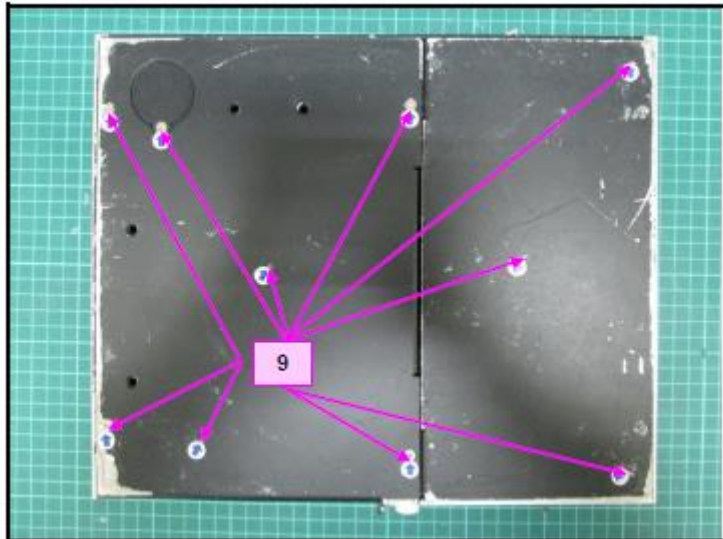
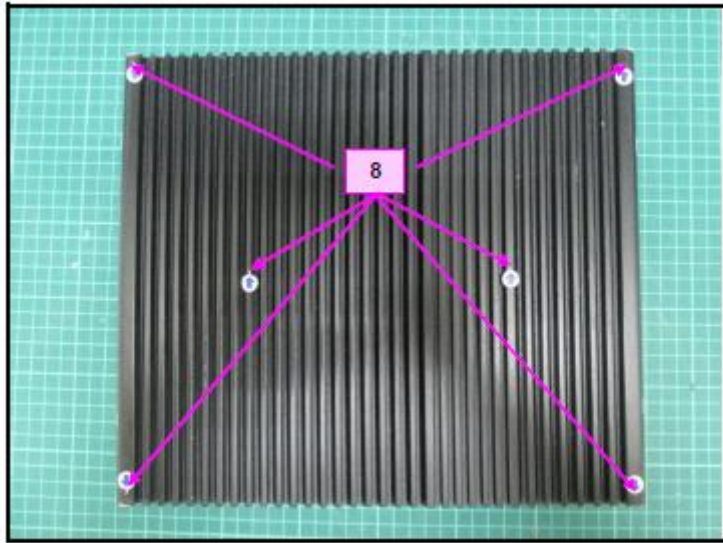

Input Power	230 Vac, 50 Hz	Tested by	Evan Liao
Environmental Conditions	23 °C, 40 % RH 988 mbar	Test Date	2019/03/26
Test Mode	2		

Test Results of Direct Application					
Discharge Level (kV)	Polarity (+/-)	Test Point	Contact Discharge	Air Discharge	Performance Criterion
2, 4, 8	+/-	10-12	NA	Note 1	A
2, 4	+/-	1-9	Note 1	NA	A

Description of test points of direct application: Please refer to following page for representative mark only.

Test Results of Indirect Application					
Discharge Level (kV)	Polarity (+/-)	Test Point	Horizontal Coupling Plane	Vertical Coupling Plane	Performance Criterion
2, 4	+/-	Four Sides	Note 1	Note 1	A

Description of test points of indirect application:

1. Front side 2. Rear side 3. Right side 4. Left side

Note: 1. The EUT function was correct during the test.

Description of Test Points

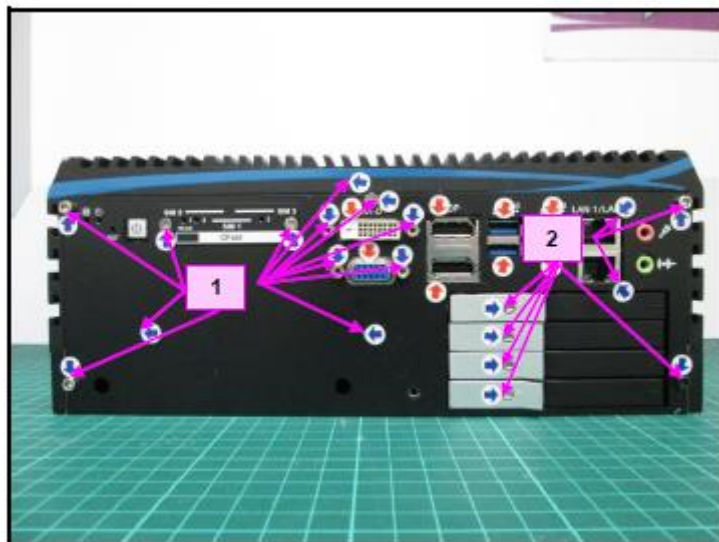
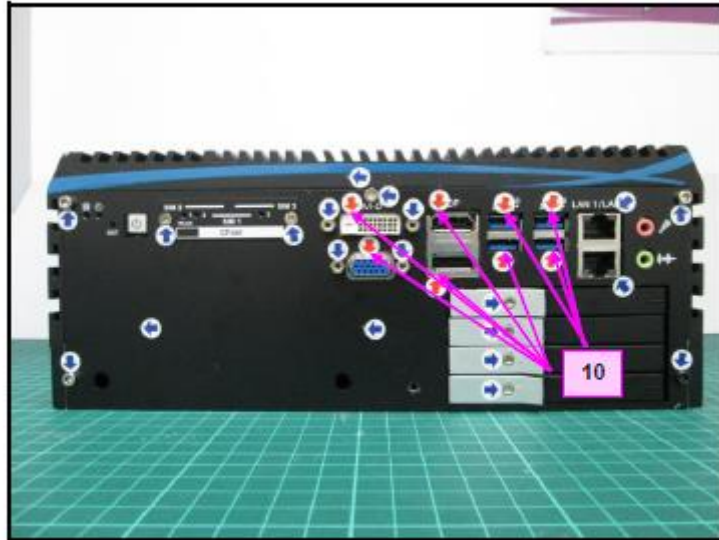

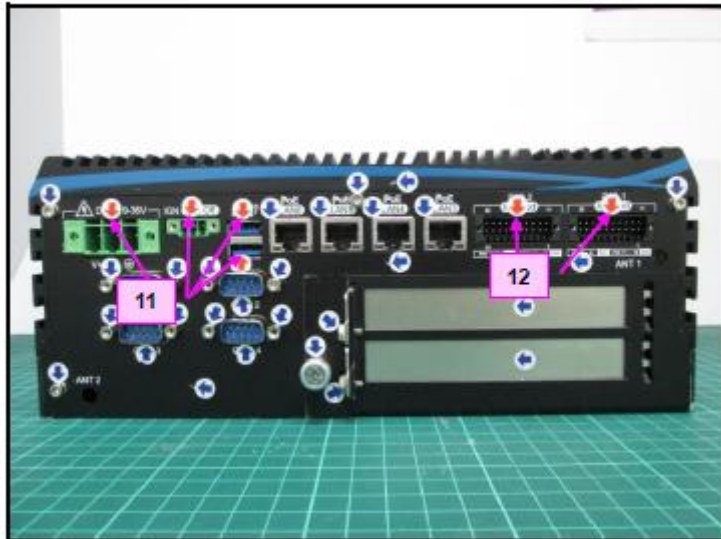

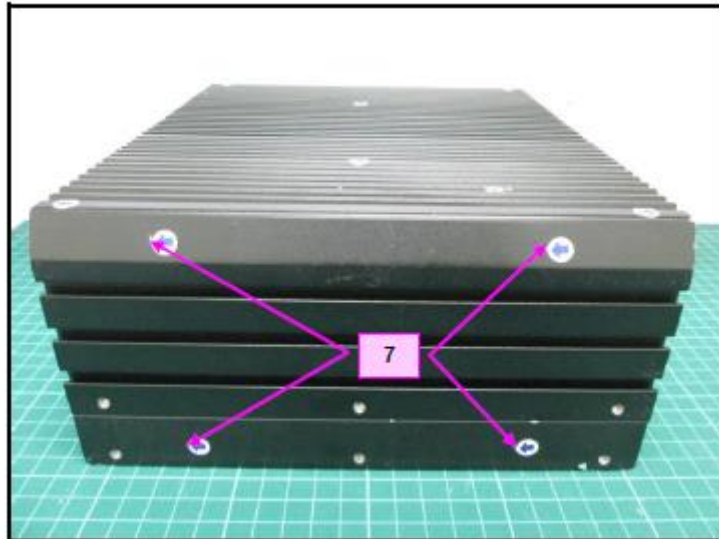
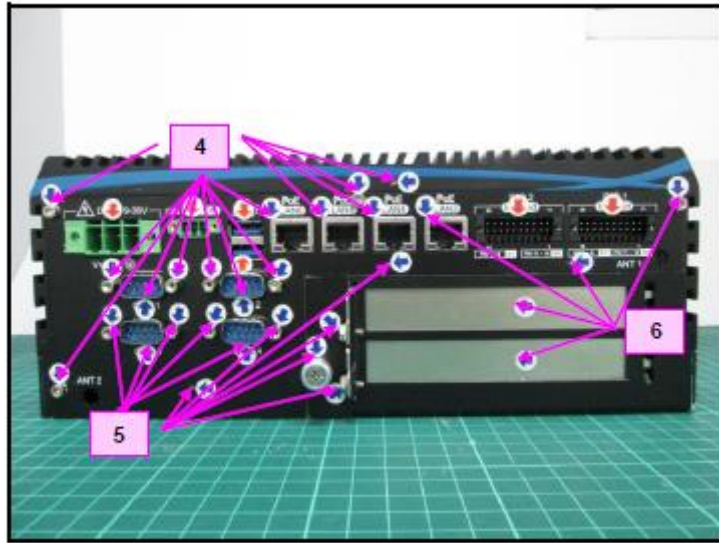

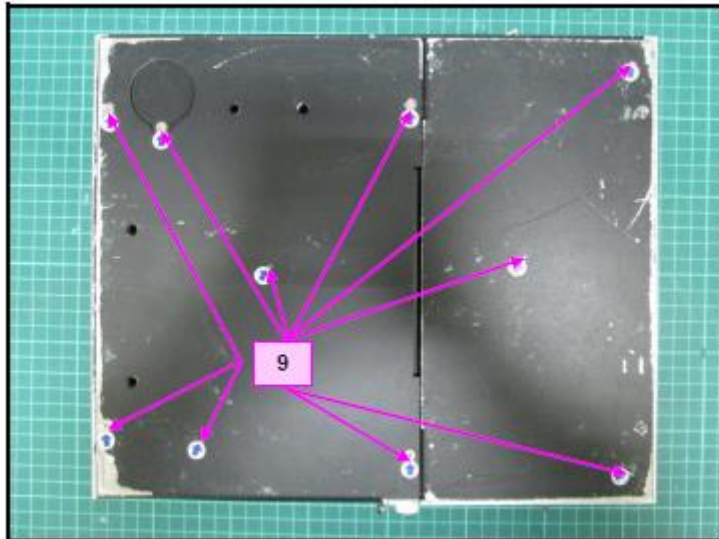
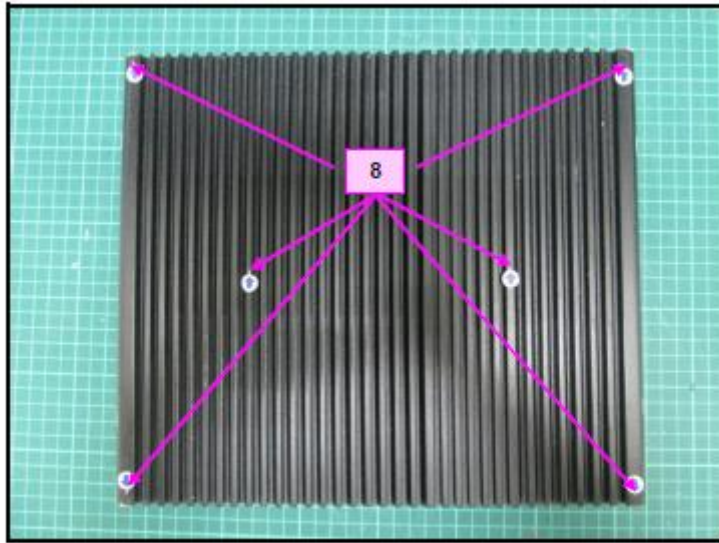

Input Power	230 Vac, 50 Hz	Tested by	Regan Wang
Environmental Conditions	23 °C, 40 % RH 988 mbar	Test Date	2019/03/26
Test Mode	3		

Test Results of Direct Application

Discharge Level (kV)	Polarity (+/-)	Test Point	Contact Discharge	Air Discharge	Performance Criterion
2, 4, 8	+/-	10-12	NA	Note 1	A
2, 4	+/-	1-9	Note 1	NA	A

Description of test points of direct application: Please refer to following page for representative mark only.

Test Results of Indirect Application

Discharge Level (kV)	Polarity (+/-)	Test Point	Horizontal Coupling Plane	Vertical Coupling Plane	Performance Criterion
2, 4	+/-	Four Sides	Note 1	Note 1	A

Description of test points of indirect application:

1. Front side 2. Rear side 3. Right side 4. Left side

Note: 1. The EUT function was correct during the test.

Description of Test Points

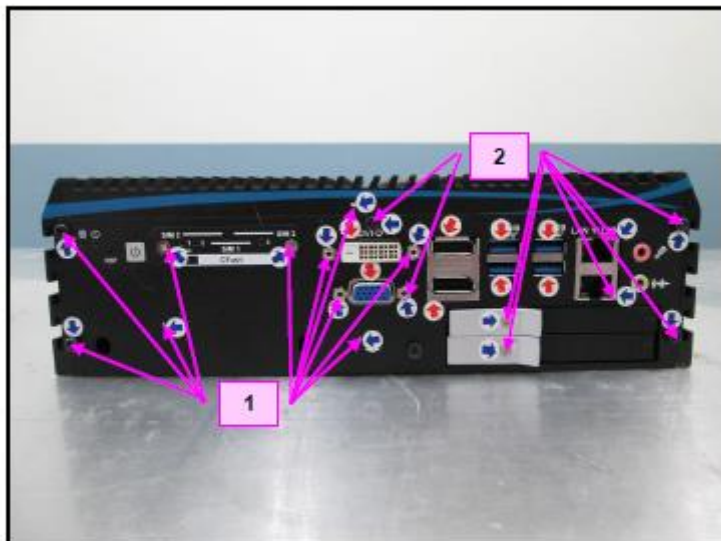
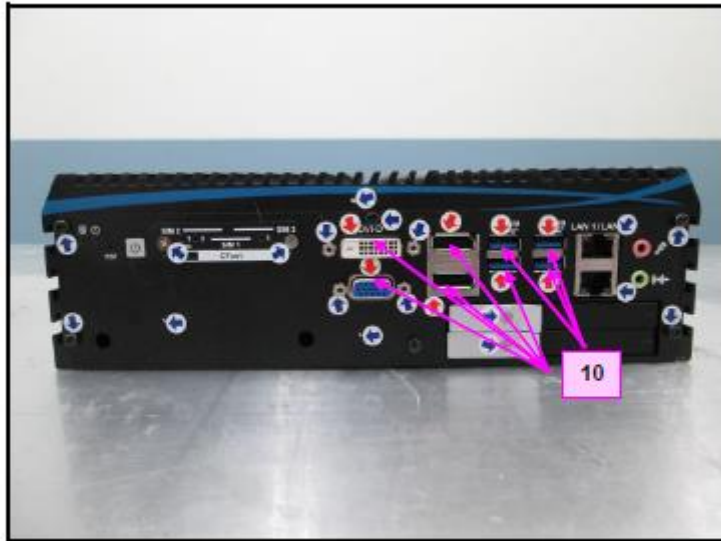

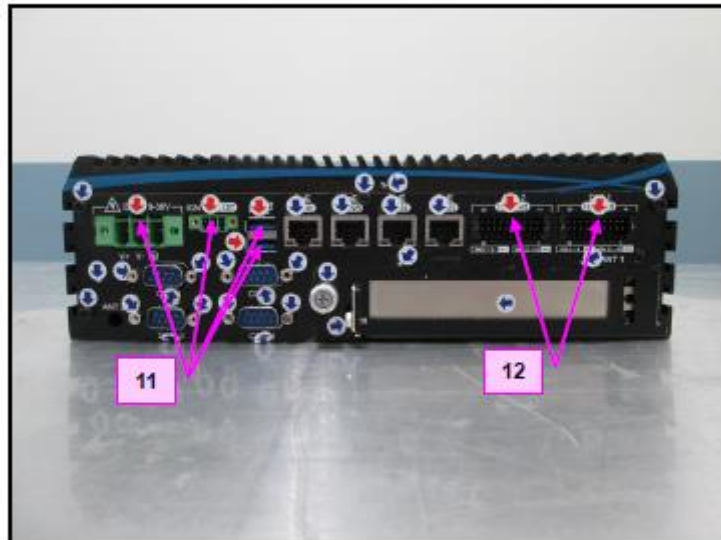
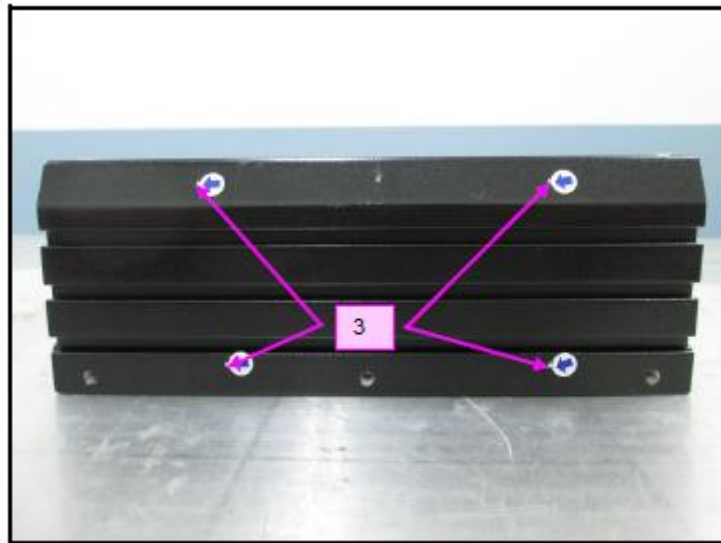

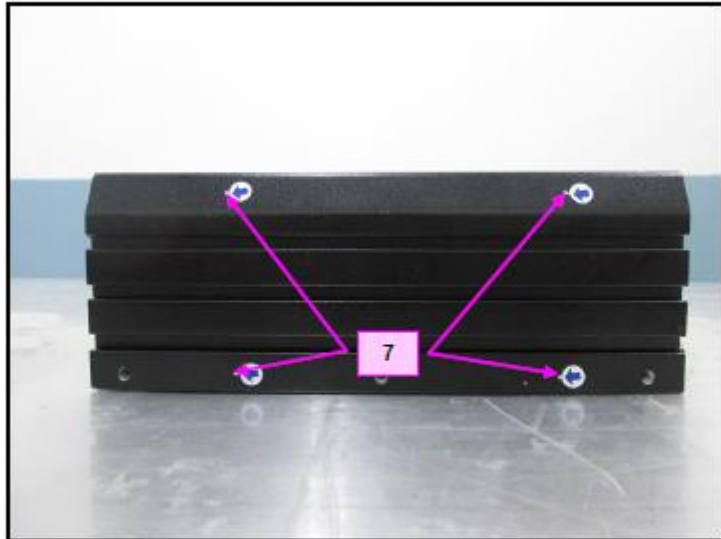
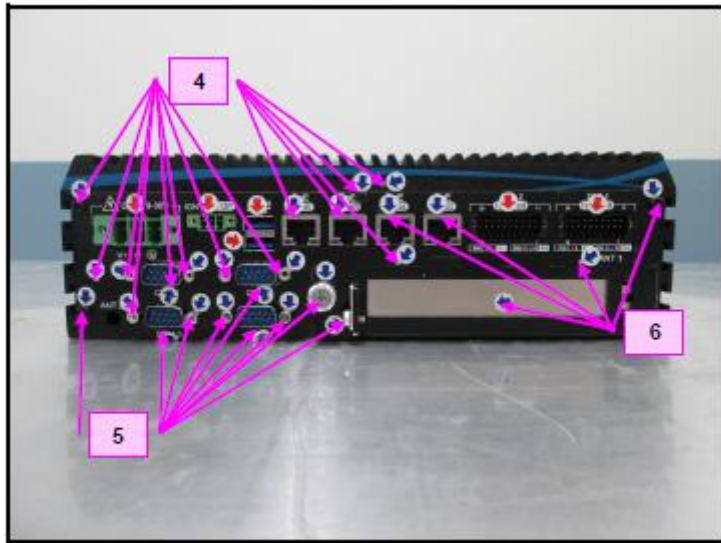

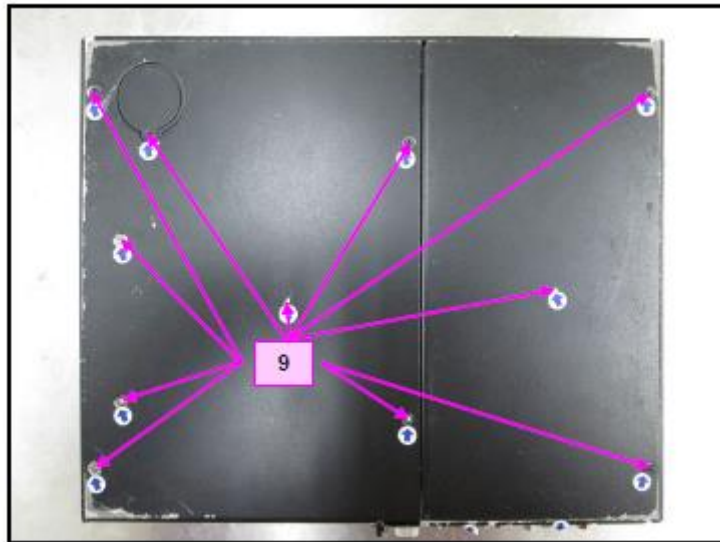
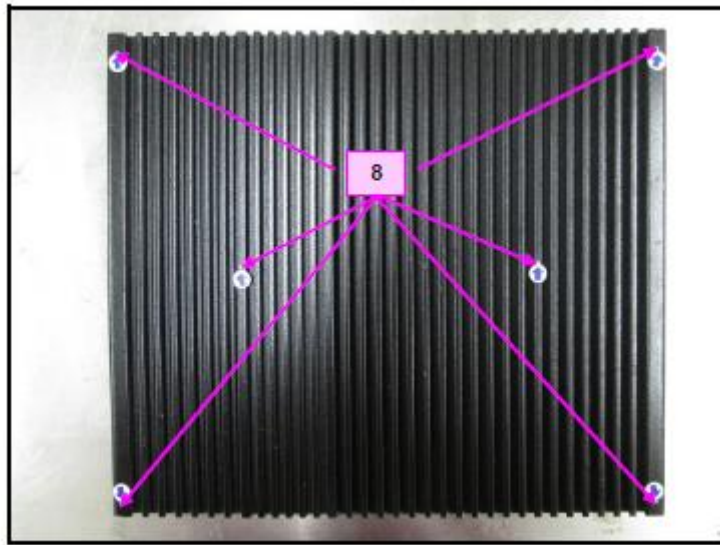

13 Radiated, Radio-frequency, Electromagnetic Field Immunity Test (RS)

13.1 Test Specification

Basic Standard:	EN/IEC 61000-4-3
Frequency Range:	80 MHz - 1000 MHz
Field Strength:	3 V/m
Modulation:	1 kHz Sine Wave, 80 %, AM Modulation
Frequency Step:	1 % of preceding frequency value
Polarity of Antenna:	Horizontal and Vertical
Antenna Height:	1.55 m
Dwell Time:	3 seconds

13.2 Test Instruments

Description & Manufacturer	Model No.	Serial No.	Cal. Date	Cal. Due
BONN Power Amp	BLMA 1060-100/50D	118694	NA	NA
BBA Power Amp	B250C125	101011	NA	NA
Power Sensor	NRP-Z91	101572	Jan. 24, 2019	Jan. 23, 2020
Power Sensor	NRP-Z91	101573	Jan. 18, 2019	Jan. 17, 2020
Signal Generator	SMB100A	105801	Jan. 17, 2019	Jan. 16, 2020
R&S Software	EMC32 Version 8.52.0	NA	NA	NA
Stacked Log-Per Antenna	STLP9149	9149-141	NA	NA
High GAIN LOG-Periodic Antenna	HL046E	100114	NA	NA

- Notes:
1. The test was performed in Hwa Ya RS Room 2.
 2. The calibration interval of the above test instruments is 12 months and the calibrations are traceable to NML/ROC and NIST/USA.
 3. The transmit antenna was located at a distance of 3 meters from the EUT.

13.3 Test Arrangement

The test procedure was in accordance with EN/IEC 61000-4-3.

- a. The testing was performed in a modified semi-anechoic chamber.
- b. The frequency range is swept from 80 MHz to 1000 MHz, with the signal 80 % amplitude modulated with a 1 kHz sine wave.
- c. The field strength level was 3 V/m.
- d. The test was performed with the EUT exposed to both vertically and horizontally polarized fields on each of the four sides (We have pretested all test modes at front (0°) side to select the worst mode. According to the pretest result, only the worst mode was tested at four sides and other modes were tested at front side according to the worst side tested at pretested.)

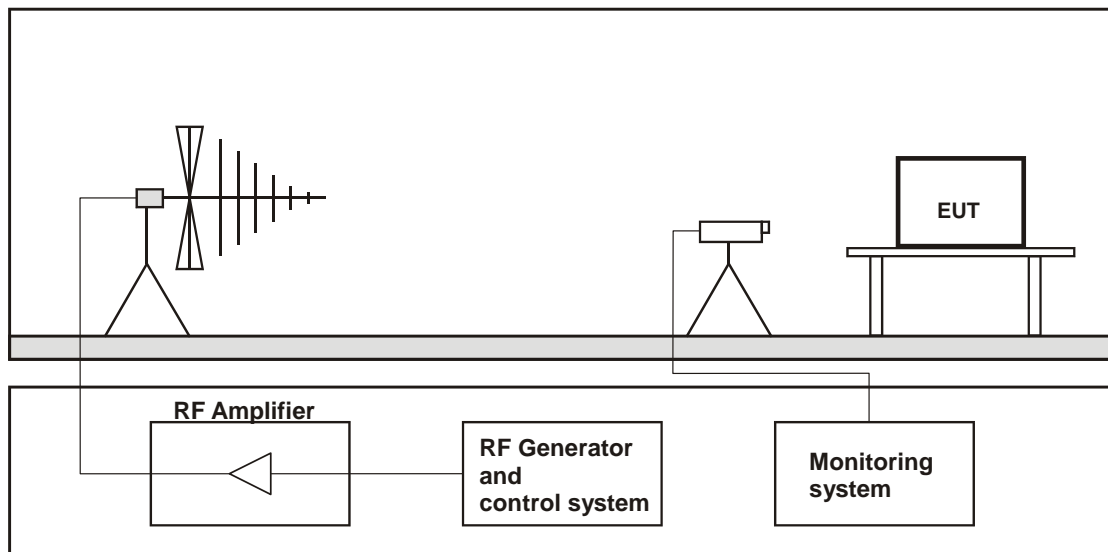

13.4 Test Results

Input Power	230 Vac, 50 Hz	Tested by	Evan Liao
Environmental Conditions	23 °C, 58 % RH	Test Date	2019/02/25
Test Mode	1		

Frequency (MHz)	Polarity	Azimuth(°)	Applied Field Strength		Observation	Performance Criterion
			(V/m)	Modulation		
80 -1000	V&H	0	3	80% AM (1 kHz)	Note 1	A
80 -1000	V&H	90	3	80% AM (1 kHz)	Note 1	A
80 -1000	V&H	180	3	80% AM (1 kHz)	Note 1	A
80 -1000	V&H	270	3	80% AM (1 kHz)	Note 1	A

Note: 1. The EUT function was correct during the test.

Input Power	230 Vac, 50 Hz	Tested by	Evan Liao
Environmental Conditions	23 °C, 58 % RH	Test Date	2019/02/25
Test Mode	2, 3		

Frequency (MHz)	Polarity	Azimuth(°)	Applied Field Strength		Observation	Performance Criterion
			(V/m)	Modulation		
80 -1000	V&H	0	3	80% AM (1 kHz)	Note 1	A

Note: 1. The EUT function was correct during the test.

14 Electrical Fast Transient/Burst Immunity Test (EFT)

14.1 Test Specification

Basic Standard:	EN/IEC 61000-4-4
Test Voltage:	Signal / telecommunication port: ± 0.5 kV Input DC power port: N/A Input AC power port: ± 1 kV
Impulse Repetition Frequency:	xDSL telecommunication port: N/A others: 5 kHz
Impulse Wave Shape:	5/50 ns
Burst Duration:	0.75 ms for 100 kHz Repetition Frequency 15 ms for 5 kHz Repetition Frequency,
Burst Period:	300 ms
Test Duration:	1 min.

14.2 Test Instruments

Description & Manufacturer	Model No.	Serial No.	Cal. Date	Cal. Due
EMC Immunity Test System	NSG 3060/ CDN 3061/ VAR 3005-S16/ CDN 3425	1385/1355/857/17 63	Oct. 09, 2018	Oct. 08, 2019

- Notes: 1. The test was performed in Hwa Ya EMS Room 2.
2. The calibration interval of the above test instruments is 12 months and the calibrations are traceable to NML/ROC and NIST/USA.

14.3 Test Arrangement

- Both positive and negative polarity discharges were applied.
- The distance between any coupling devices and the EUT should be 0.5 m for table-top equipment testing, and 1.0 m for floor standing equipment.
- The duration time of each test sequential was 1 minute.
- The transient/burst waveform was in accordance with EN/IEC 61000-4-4, 5/50 ns.

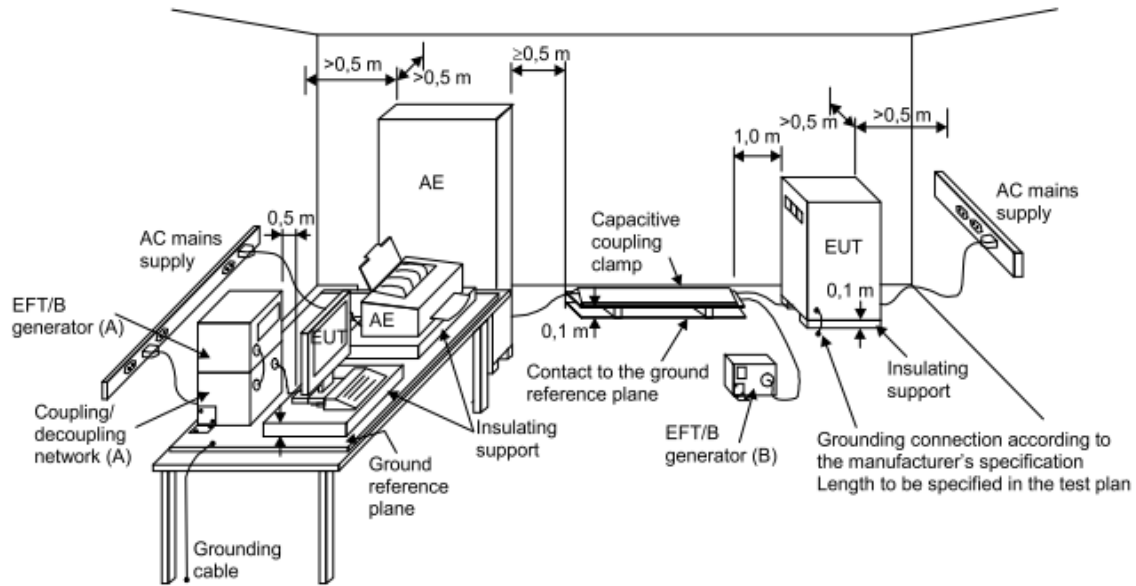

IEC 645/12

14.4 Test Results

Input Power	230 Vac, 50 Hz	Tested by	Water Su, Howard Yang
Environmental Conditions	22 °C, 59 % RH	Test Date	2019/02/13
Test Mode	1-3		

Input DC/AC power port

Voltage (kV)	Test Point	Polarity (+/-)	Observation	Performance Criterion
1	L1	+/-	Note 1	A
1	L2	+/-	Note 1	A
1	PE	+/-	Note 1	A
1	L1-L2-PE	+/-	Note 1	A

Note: 1. The EUT function was correct during the test.

Input Power	230 Vac, 50 Hz	Tested by	Water Su, Howard Yang
Environmental Conditions	22 °C, 59 % RH	Test Date	2019/02/13
Test Mode	4, 6		

Signal / telecommunication port

Voltage (kV)	Test Point	Polarity (+/-)	Observation	Performance Criterion
0.5	LAN 1	+/-	Note 1	A

Note: 1. The EUT function was correct during the test.

Input Power	230 Vac, 50 Hz	Tested by	Water Su, Howard Yang
Environmental Conditions	22 °C, 59 % RH	Test Date	2019/02/13
Test Mode	5, 7		

Signal / telecommunication port

Voltage (kV)	Test Point	Polarity (+/-)	Observation	Performance Criterion
0.5	POE LAN 6	+/-	Note 1	A

Note: 1. The EUT function was correct during the test.

15 Surge Immunity Test

15.1 Test Specification

Basic Standard:	EN/IEC 61000-4-5
Wave-Shape:	Signal / telecommunication port (direct to outdoor cables*): 10/700 μ s Open Circuit Voltage 5/320 μ s Short Circuit Current Input DC power port (direct to outdoor cables*): 1.2/50 μ s Open Circuit Voltage 8/20 μ s Short Circuit Current Input AC power port: 1.2/50 μ s Open Circuit Voltage 8/20 μ s Short Circuit Current
Test Voltage:	Signal and telecommunication ports**: w/o primary protectors: N/A, with primary protectors fitted: N/A Input DC power port: Line to earth or ground: N/A Input AC power ports: Line to line: ± 1 kV, Line to earth or ground: ± 2 kV
AC Phase Angle (degree):	0°, 90°, 180°, 270°
Pulse Repetition Rate:	1 time / 60 sec.
Number of Tests:	5 positive and 5 negative at selected points

* This test is only applicable only to ports, which according to the manufacturer's specification, may connect directly to outdoor cables.

** For ports where primary protection is intended, surges are applied at voltages up to 4 kV with the primary protectors fitted. Otherwise the 1 kV test level is applied without primary protection in place.

15.2 Test Instruments

Description & Manufacturer	Model No.	Serial No.	Cal. Date	Cal. Due
EMC Immunity Test System	NSG 3060	1385	Oct. 09, 2018	Oct. 08, 2019
EMC Immunity Test System	CDN 3061	1355	Oct. 09, 2018	Oct. 08, 2019
EMC Immunity Test System	VAR 3005-S16	857	Oct. 09, 2018	Oct. 08, 2019
Surge CDN	CDN HSS-2	36541	Oct. 09, 2018	Oct. 08, 2019
CDN for Unshielded symmetrical signal & Data Lines	CDN 118 / INA 172 / INA 175 / INA 180 / INA 181 / INA 182 / INA 183	33882 / 33245 / 35809 / 35806 / 35909 / 35912 / 35917 / 35927	Oct. 09, 2018	Oct. 08, 2019

Notes: 1. The test was performed in Hwa Ya EMS Room 2.

2. The calibration interval of the above test instruments is 12 months and the calibrations are traceable to NML/ROC and NIST/USA.

15.3 Test Arrangement

a. Input AC/DC Power ports:

The surge is to be applied to the EUT power supply terminals via the capacitive coupling network.

Decoupling networks are required in order to avoid possible adverse effects on equipment not under test that may be powered by the same lines, and to provide sufficient decoupling impedance to the surge wave. The power cord between the EUT and the coupling/decoupling networks shall be 2 meters in length (or shorter).

For double-insulated products without PE or external earth connections, the test shall be done in a similar way as for grounded products but without adding any additional external grounded connections. If there are no other possible connections to earth, line-to-ground tests may be omitted.

b. Signal and telecommunication ports,

- Unshielded unsymmetrical interconnection lines:

The surge is applied to the lines via the capacitive coupling. The coupling / decoupling networks shall not influence the specified functional conditions of the EUT. The interconnection line between the EUT and the coupling/decoupling networks shall be 2 meters in length.

- Unshielded symmetrical interconnections communication lines:

The surge is applied to the lines via gas arrestors coupling. Test levels below the ignition point of the coupling arrestor cannot be specified. The interconnection line between the EUT and the coupling/decoupling networks shall be 2 meters in length.

- High speed communications lines

Prior to the test, the correct operation of the port shall be verified; the external connection shall then be removed and the surge applied directly to the port's terminals with no coupling /decoupling network. After the surge, the correct operation of the port shall again be verified.

- Shielded lines:

- Direct application,

The EUT is isolated from ground and the surge is applied to its metallic enclosure; the termination (or auxiliary equipment) at the port(s) under test is grounded. This test applies to equipment with single or multiple shielded cables.

Rules for application of the surge to shielded lines:

- a) Shields grounded at both ends

- The surge injection on the shield.

- b) Shields grounded at one end

- If in the installation the shield is connected only at the auxiliary equipment, test shall be done in that configuration but with the generator still connected to the EUT side. If cable lengths allow, the cables shall be on insulated supports 0,1 m above the ground plane or cable tray.

For products which do not have metallic enclosures, the surge is applied directly to the shielded cable.

- Alternative coupling method for testing single cables in a multi-shield configuration,

Surges are applied in close proximity to the interconnection cable under test by a wire. The length of the cable between the port(s) under test and the device attached to the other end of the cable shall be the lesser of: the maximum length permitted by the EUT's specification, or 20 m. Where the length exceeds 1 m, excess lengths of cables shall be bundled at the approximate centre of the cables with the bundles 30 cm to 40 cm in length.

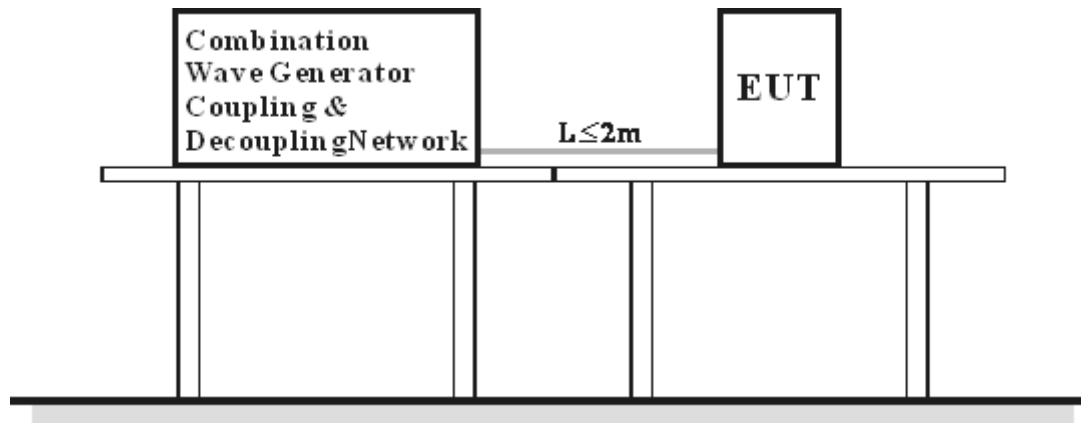

15.4 Test Results

Input Power	230 Vac, 50 Hz	Tested by	Howard Yang
Environmental Conditions	22 °C, 59 % RH	Test Date	2019/02/25
Test Mode	1-3		

Input DC/AC power port

Voltage (kV)	Test Point	Polarity (+/-)	Observation	Performance Criterion
0.5, 1	L1-L2	+/-	Note 1	A
0.5, 1, 2	L1-PE	+/-	Note 1	A
0.5, 1, 2	L2-PE	+/-	Note 1	A

Note: 1. The EUT function was correct during the test.

16 Immunity to Conducted Disturbances Induced by RF Fields (CS)

16.1 Test Specification

Basic Standard:	EN/IEC 61000-4-6
Frequency Range:	0.15 MHz - 80 MHz
Voltage Level:	3 V
Modulation:	1 kHz Sine Wave, 80 %, AM Modulation
Frequency Step:	1 % of preceding frequency value
Dwell Time	3 seconds

16.2 Test Instruments

Description & Manufacturer	Model No.	Serial No.	Cal. Date	Cal. Due
FCC SIGNAL LINE POWER LINE COUPLING DECOUPLING NETWORK	FCC-801-M2/M3-16A	112388	Mar. 04, 2019	Mar. 03, 2020
Coupling Decoupling Network TESEQ	CDN T8_Cat.6	39921	Mar. 04, 2019	Mar. 03, 2020
R&S Power Amplifier	BBA100	101012	NA	NA
R&S Signal generator	SMB100A	105802	Jan. 24, 2019	Jan. 23, 2020
R&S Software	EMC32 Version 8.52.0	NA	NA	NA
Power Sensor	NRP-Z91	101574	Jun. 26, 2018	Jun. 25, 2019
Power Sensor	NRP-Z91	101575	Jun. 08, 2018	Jun. 07, 2019
EAR SIMULATOR	4192	2764583	Oct. 11, 2018	Oct. 10, 2019
Conditioning Amplifier	Type 2690-0S2	2482371	Jun. 11, 2018	Jun. 10, 2019
Audio analyzer	UPV	101942	Dec. 18, 2018	Dec. 17, 2019

Notes: 1. The test was performed in Hwa Ya CS Room 2.

2. The calibration interval of the above test instruments is 12 months and the calibrations are traceable to NML/ROC and NIST/USA.

16.3 Test Arrangement

- The EUT shall be tested within its intended operating and climatic conditions.
- An artificial hand was placed on the hand-held accessory and connected to the ground reference plane.
- One of the CDNs not used for injection was terminated with 50 ohm, providing only one return path. All other CDNs were coupled as decoupling networks.
- The frequency range is swept from 150 kHz to 80 MHz, using the signal level established during the setting process and with a disturbance signal of 80 % amplitude. The signal is modulated with a 1 kHz sine wave, pausing to adjust the RF signal level or the switch coupling devices as necessary. Where the frequency is swept incrementally, the step size shall not exceed 1 % of the preceding frequency value.
- Attempts should be made to fully exercise the EUT during testing, and to fully interrogate all exercise modes selected for susceptibility.

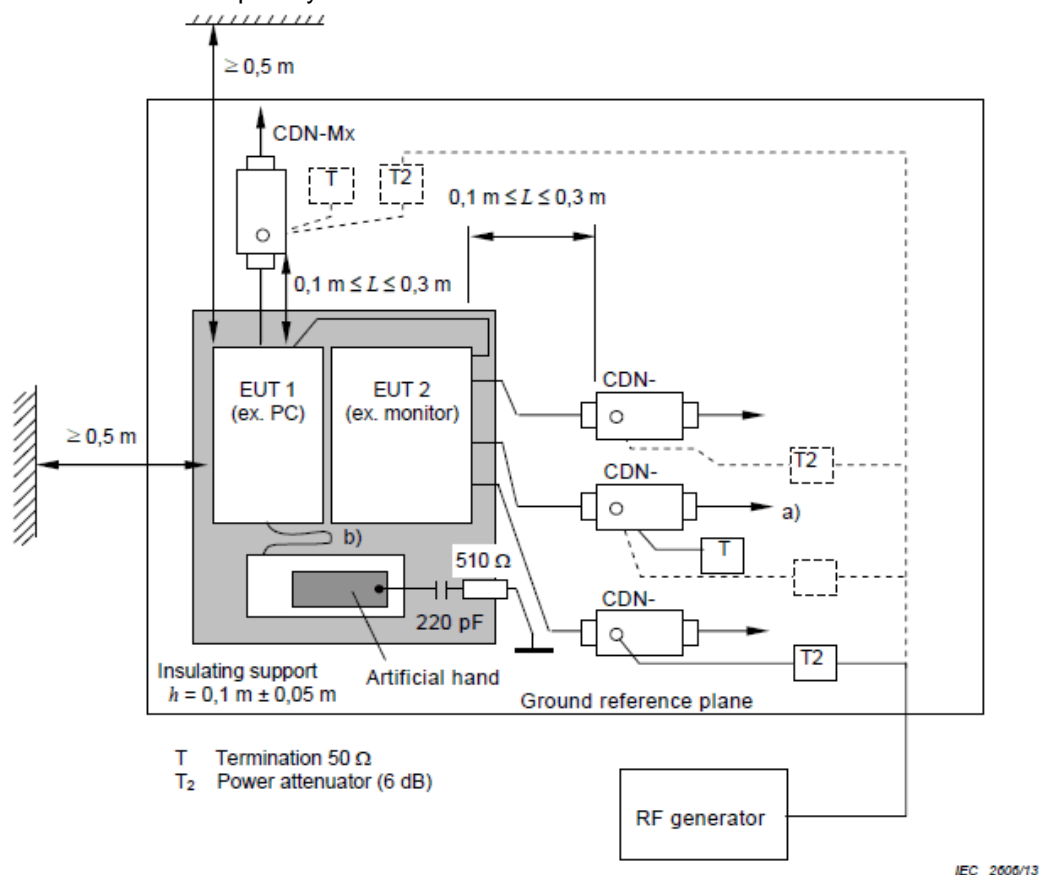

- Only one of the CDNs not used for injection shall be terminated with 50 Ω , providing only one return path. All other CDNs shall be configured as decoupling networks.
- Interconnecting cables (≤ 1 m) belonging to the EUT shall remain on the insulating support.

16.4 Test Results

Input Power	230 Vac, 50 Hz	Tested by	Evan Liao
Environmental Conditions	23 °C, 58 % RH	Test Date	2019/03/06
Test Mode	1-3		

Frequency (MHz)	Level (Vrms)	Tested Line	Injection Method	Return Path	Observation	Performance Criterion
0.15 – 80	3	AC Power	CDN-M3	CDN-M1	Note 1	A

Note: 1. The EUT function was correct during the test.

Input Power	230 Vac, 50 Hz	Tested by	Evan Liao
Environmental Conditions	23 °C, 58 % RH	Test Date	2019/03/06
Test Mode	4, 6		

Frequency (MHz)	Level (Vrms)	Tested Line	Injection Method	Return Path	Observation	Performance Criterion
0.15 – 80	3	LAN 1	CDN-T8	CDN-M1	Note 1	A

Note: 1. The EUT function was correct during the test.

Input Power	230 Vac, 50 Hz	Tested by	Evan Liao, Shawn Huang
Environmental Conditions	23 °C, 58 % RH	Test Date	2019/03/07
Test Mode	5, 7		

Frequency (MHz)	Level (Vrms)	Tested Line	Injection Method	Return Path	Observation	Performance Criterion
0.15 – 80	3	POE LAN 6	CDN-T8	CDN-M1	Note 1	A

Note: 1. The EUT function was correct during the test.

17 Power Frequency Magnetic Field Immunity Test

17.1 Test Specification

Basic Standard:	EN/IEC 61000-4-8
Frequency Range:	50 Hz
Field Strength:	1 A/m
Observation Time:	1 minute
Inductance Coil:	Rectangular type, 1 m x 1 m

17.2 Test Instruments

Description & Manufacturer	Model No.	Serial No.	Cal. Date	Cal. Due
F.W.BELL 4190 Gaussmeter	4190	1604006	Jan. 24, 2018	Jan. 23, 2019
Teseq Multi turn Magnetic	INA702	268	Oct. 15, 2018	Oct. 14, 2019
Schaffner AC Power Source	NSG1007	55616	Oct. 15, 2018	Oct. 14, 2019
Schaffner Signal Conditioning Unit- Lumped Impedance	CCN1000-1-LR1	72224	Oct. 15, 2018	Oct. 14, 2019

Notes: 1. The test was performed in Hwa Ya EMS Room 2.

2. The calibration interval of the above test instruments is 12 months and the calibrations are traceable to NML/ROC and NIST/USA.

17.3 Test Arrangement

- The equipment is configured and connected to satisfy its functional requirements.
- The power supply, input and output circuits shall be connected to the sources of power supply, control and signal.
- The cables supplied or recommended by the equipment manufacturer shall be used. 1 meter of all cables used shall be exposed to the magnetic field.

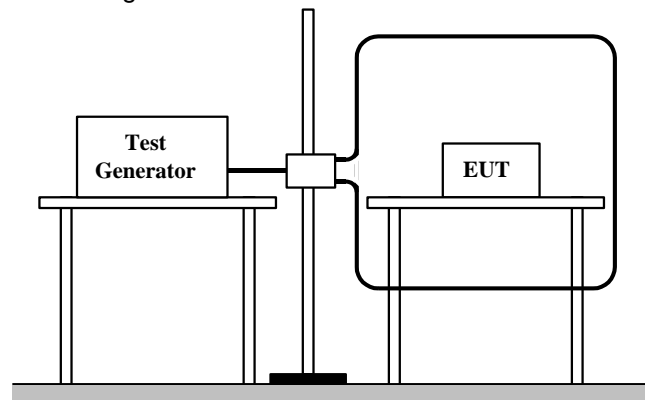

17.4 Test Results

Input Power	230 Vac, 50/60 Hz	Tested by	Howard Yang
Environmental Conditions	22 °C, 55 % RH	Test Date	2019/02/26
Test Mode	1-3		

Application	Frequency (Hz)	Field Strength (A/m)	Observation	Performance Criterion
X - Axis	50	1	Note 1	A
Y - Axis	50	1	Note 1	A
Z - Axis	50	1	Note 1	A

Note: 1. The EUT function was correct during the test.

18 Voltage Dips and Interruptions

18.1 Test Specification

Basic Standard:	EN/IEC 61000-4-11
Test levels:	Voltage Dips: >95 % reduction – 0.5 period 30 % reduction – 25 periods Voltage Interruptions: >95 % reduction – 250 periods
Interval between Event:	Minimum ten seconds
Sync Angle (degrees):	0° / 180°
Test Cycle:	3 times

18.2 Test Instruments

Description & Manufacturer	Model No.	Serial No.	Cal. Date	Cal. Due
EMC Immunity Test System	NSG 3060	1385	Oct. 09, 2018	Oct. 08, 2019
EMC Immunity Test System	CDN 3061	1355	Oct. 09, 2018	Oct. 08, 2019
EMC Immunity Test System	VAR 3005-S16	857	Oct. 09, 2018	Oct. 08, 2019

- Notes: 1. The test was performed in Hwa Ya EMS Room 2.
 2. The calibration interval of the above test instruments is 12 months and the calibrations are traceable to NML/ROC and NIST/USA.

18.3 Test Arrangement

The EUT shall be tested for each selected combination of test levels and duration with a sequence of 3 dips/interruptions with intervals of 10 s minimum (between each test event). Each representative mode of operation shall be tested. Abrupt changes in supply voltage shall occur at 0 degree crossover point of the voltage waveform.

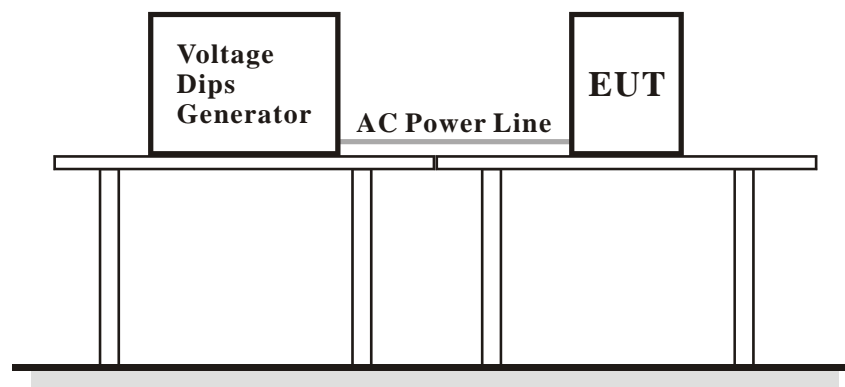

18.4 Test Results

Input Power	230 Vac, 50 Hz	Tested by	2019/02/25
Environmental conditions	22 °C, 59 % RH	Test Date	Howard Yang
Test mode	1-3		

Input Power for testing: 230 Vac, 50 Hz (Nominal input Voltage)					
Voltage Reduction (%)	Duration (period)	Interval (sec)	Times	Observation	Performance Criterion
>95	0.5	10	3	Note 1	A
30	25	10	3	Note 1	A
>95	250	10	3	Note 2	C

Input Power for testing: 240 Vac, 50 Hz (Maximum rated input voltage)					
Voltage Reduction (%)	Duration (period)	Interval (sec)	Times	Observation	Performance Criterion
>95	0.5	10	3	Note 1	A
30	25	10	3	Note 1	A
>95	250	10	3	Note 2	C

Input Power for testing: 100 Vac, 50 Hz (Minimum rated input voltage)					
Voltage Reduction (%)	Duration (period)	Interval (sec)	Times	Observation	Performance Criterion
>95	0.5	10	3	Note 1	A
30	25	10	3	Note 1	A
>95	250	10	3	Note 2	C

- Note: 1. The EUT function was correct during the test.
 2. The EUT shot down during the test, and must be recovery manally.

19 Pictures of Test Arrangements

19.1 Conducted Disturbance at Mains Ports



19.2 Asymmetric Mode Conducted Emission at Wired Network Ports



19.3 Radiated Disturbance up to 1 GHz



19.4 Radiated Disturbance above 1 GHz

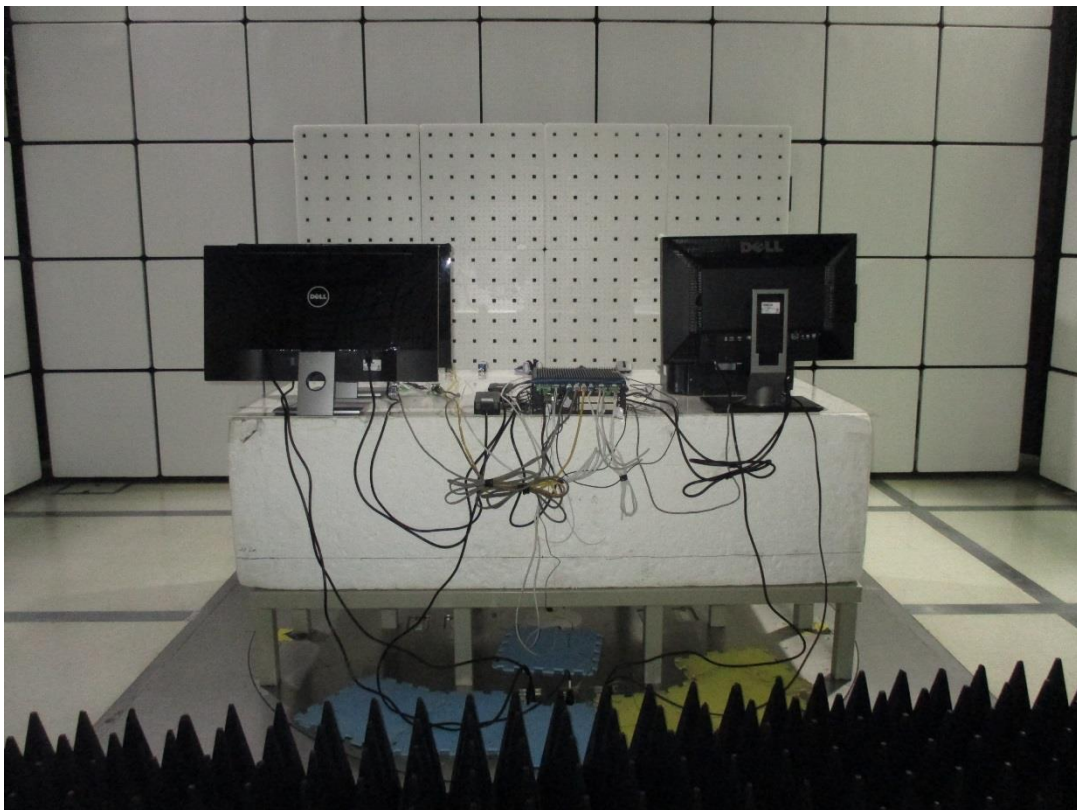
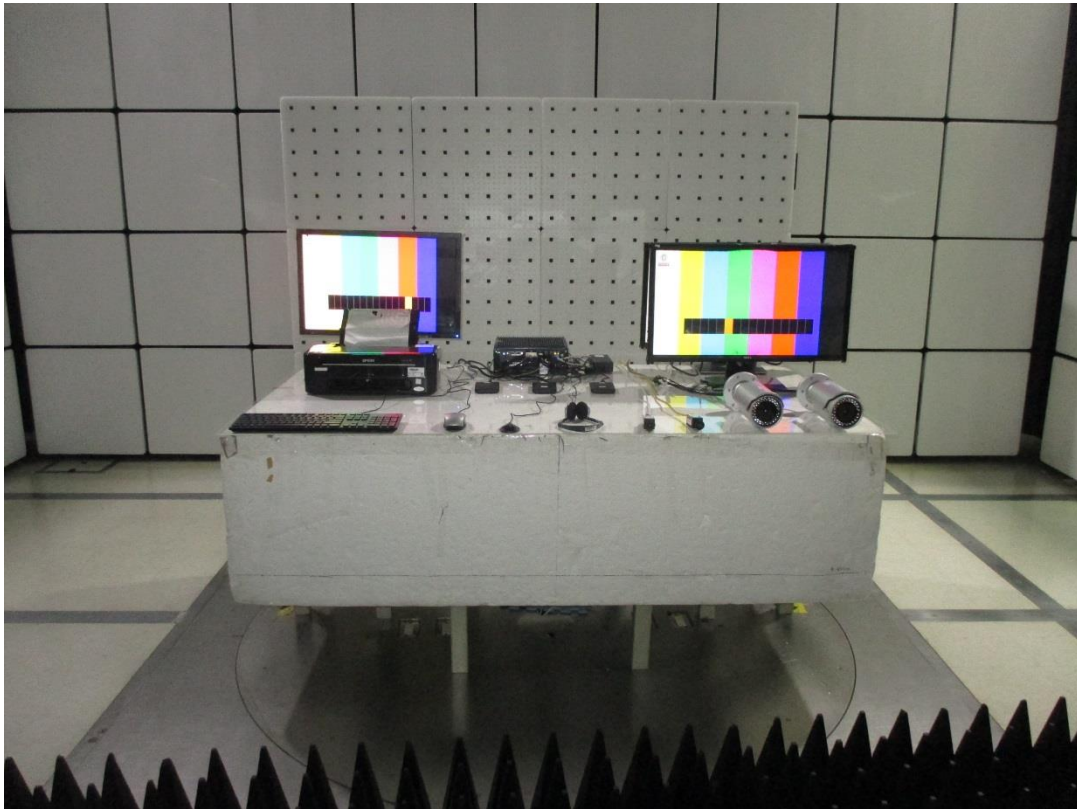

19.5 Harmonics Current, Voltage Fluctuations and Flicker Measurement

(Mode 1)



(Mode 2)



(Mode 3)



19.6 Electrostatic Discharge Immunity Test (ESD)

(Mode 1)

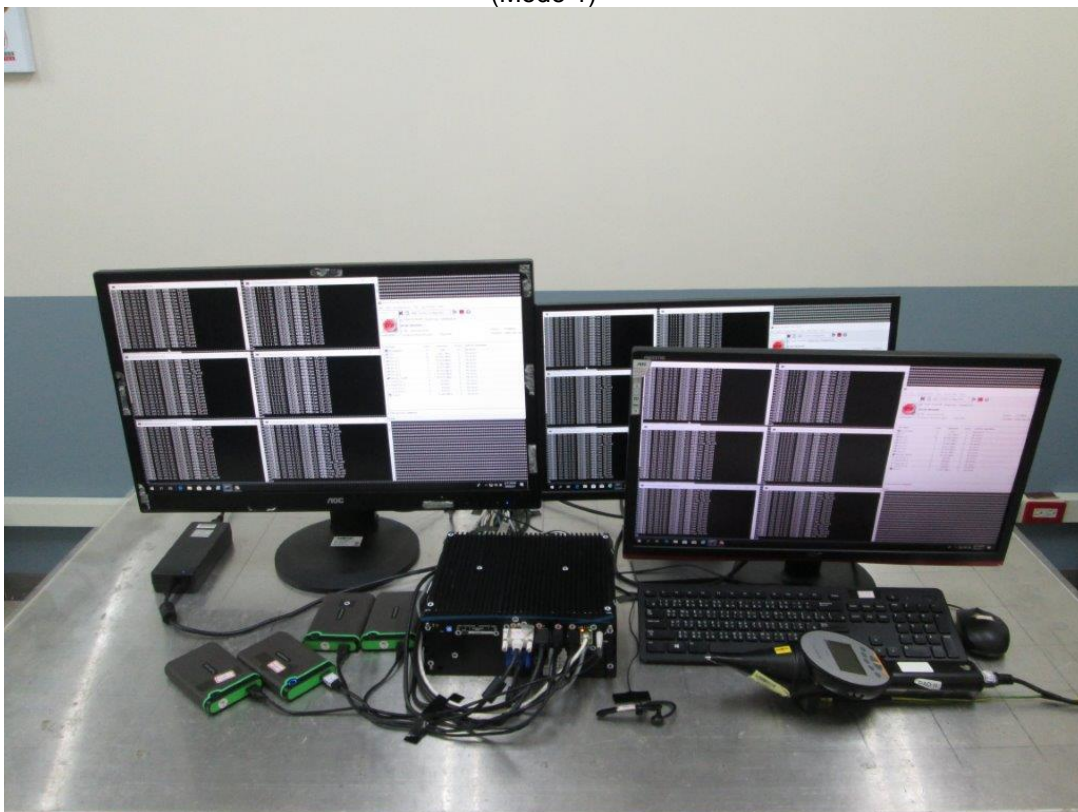

(Mode 2)



(Mode 3)

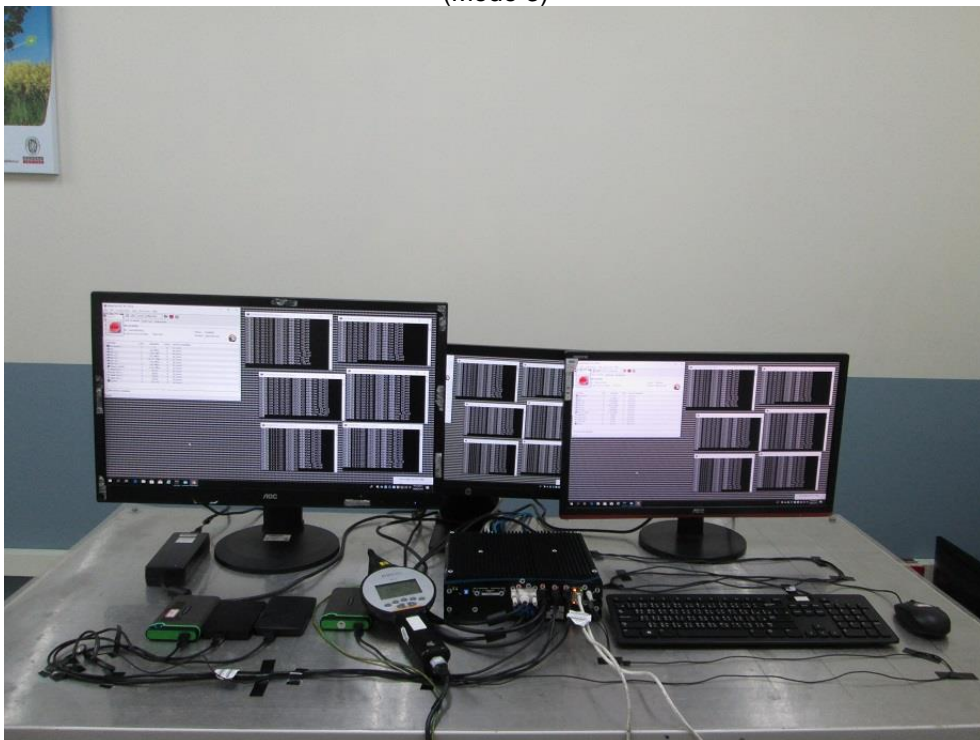

19.7 Radio-frequency, Electromagnetic Field Immunity Test (RS)

(Mode 1_0 degree)



(Mode 1_90 degree)

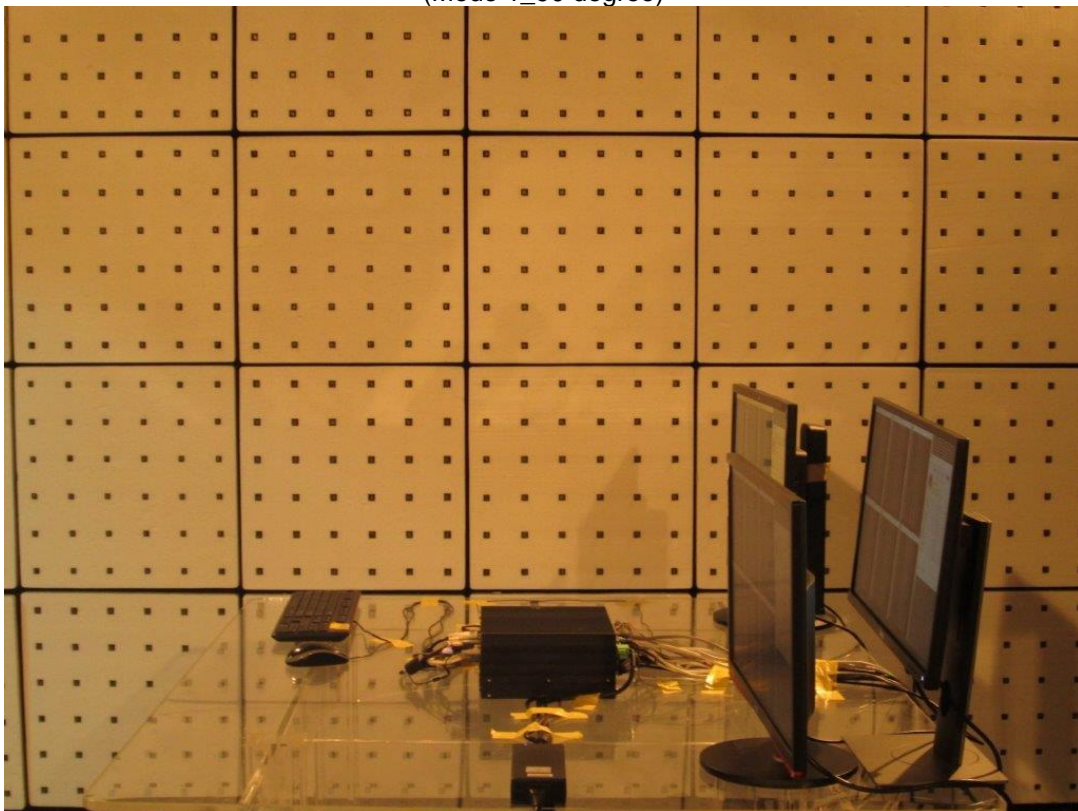

(Mode 1_180 degree)

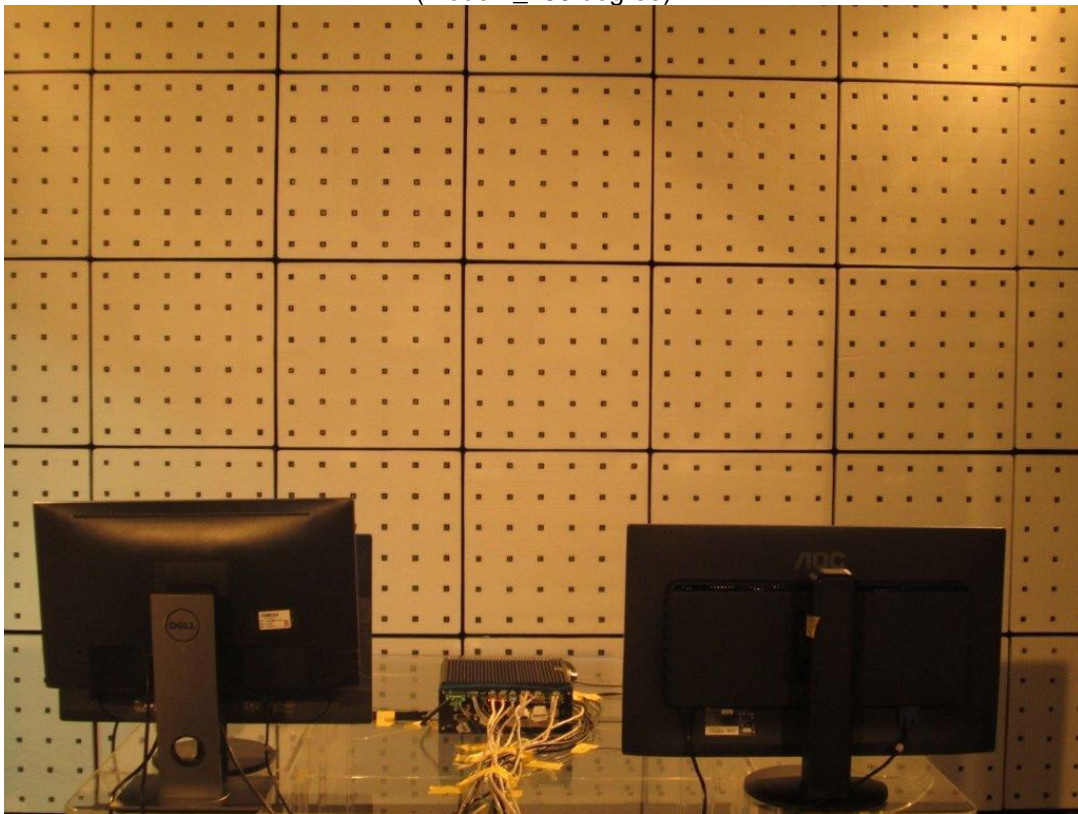

(Mode 1_270 degree)

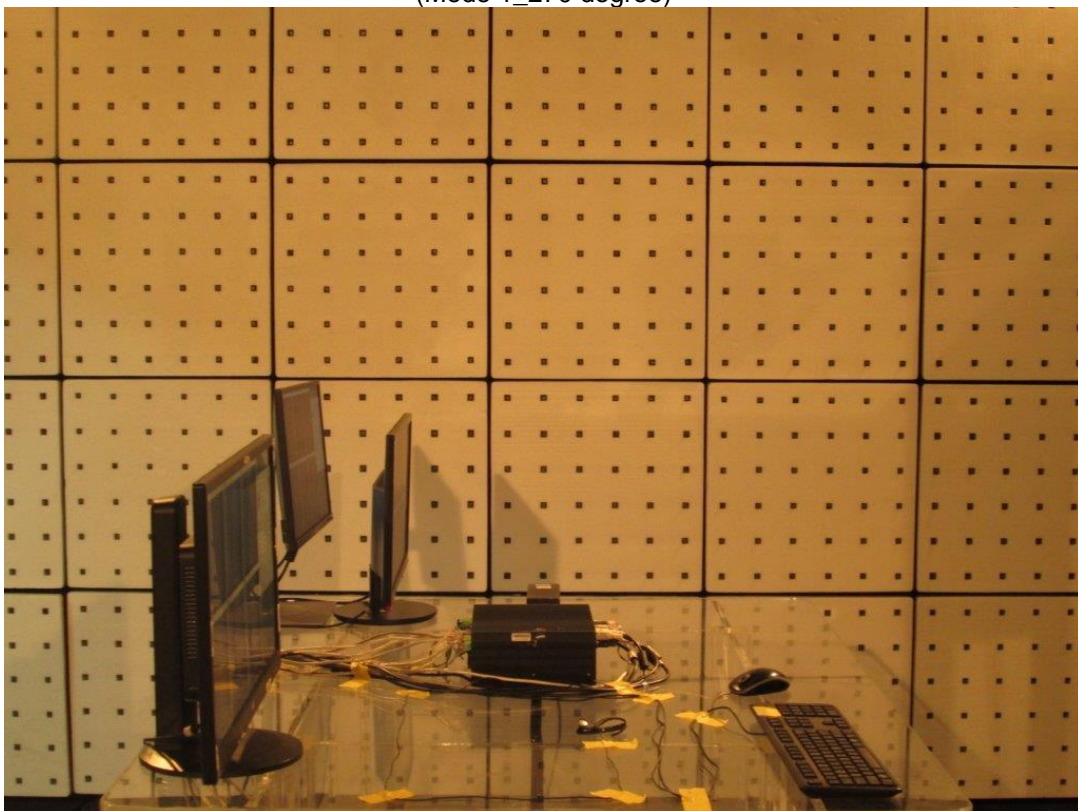

(Mode 2)



(Mode 3)

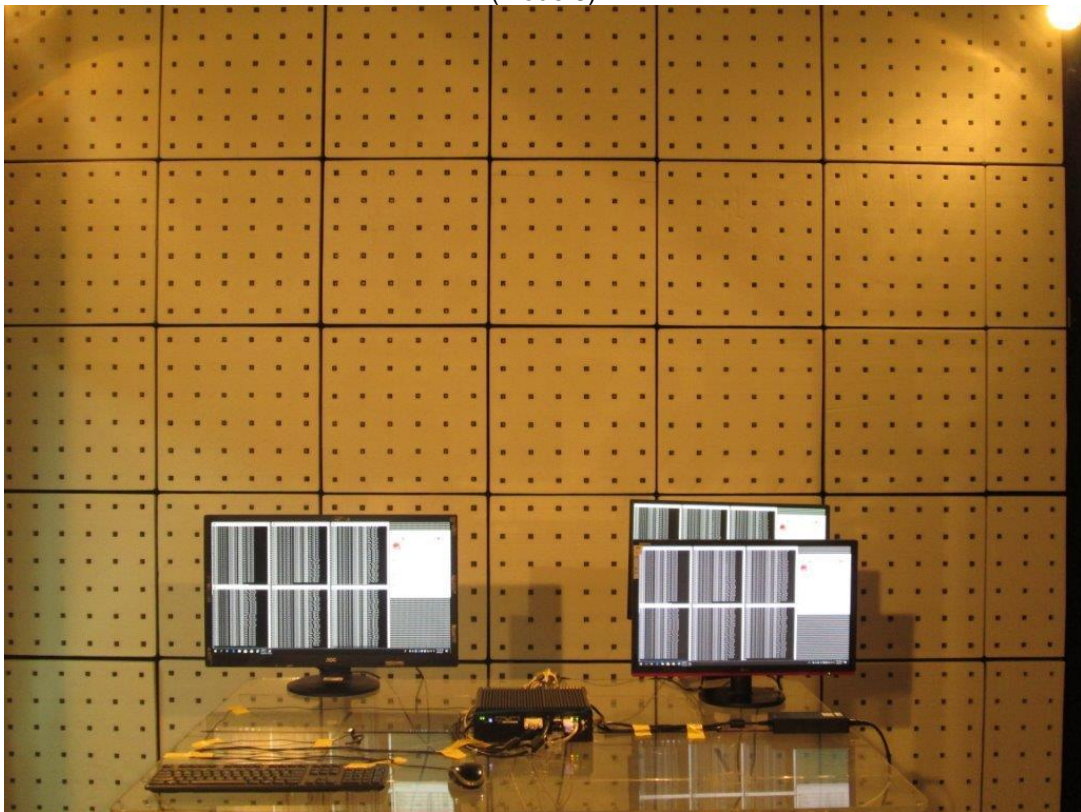

19.8 Electrical Fast Transient/Burst Immunity Test (EFT)

(Mode 1)



(Mode 2)



(Mode 3)



(Mode 4)



(Mode 5)



(Mode 6)



(Mode 7)



19.9 Surge Immunity Test

(Mode 1)

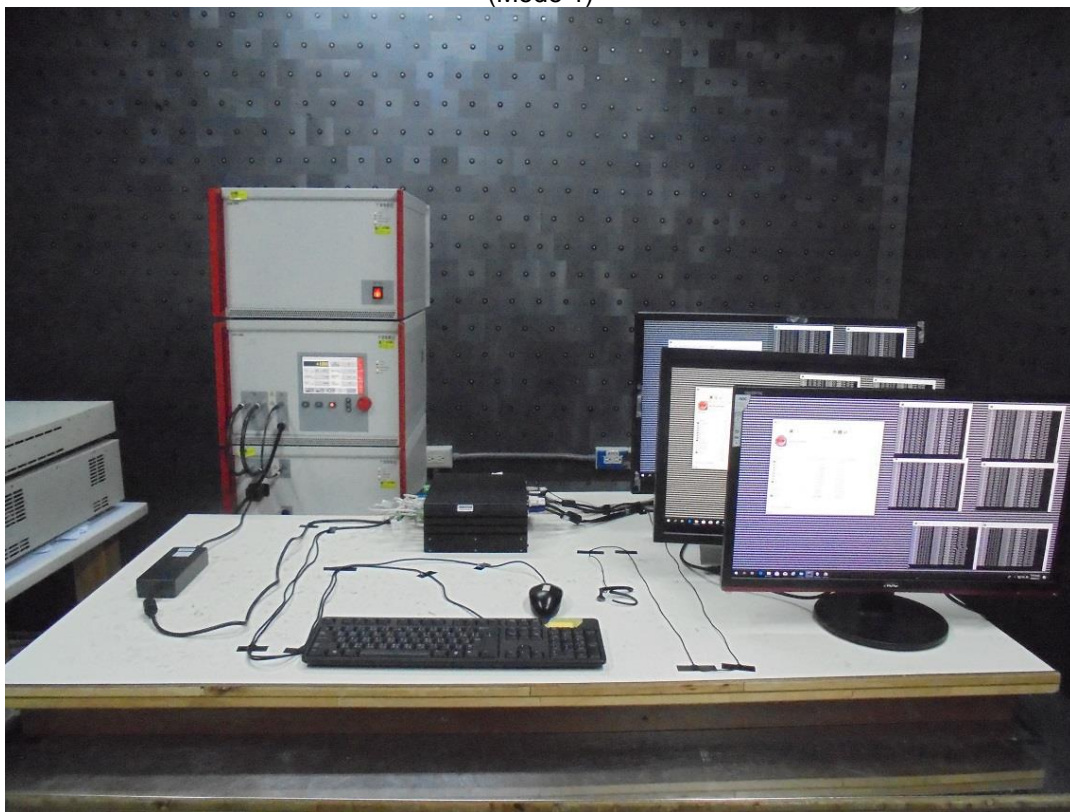

(Mode 2)



(Mode 3)

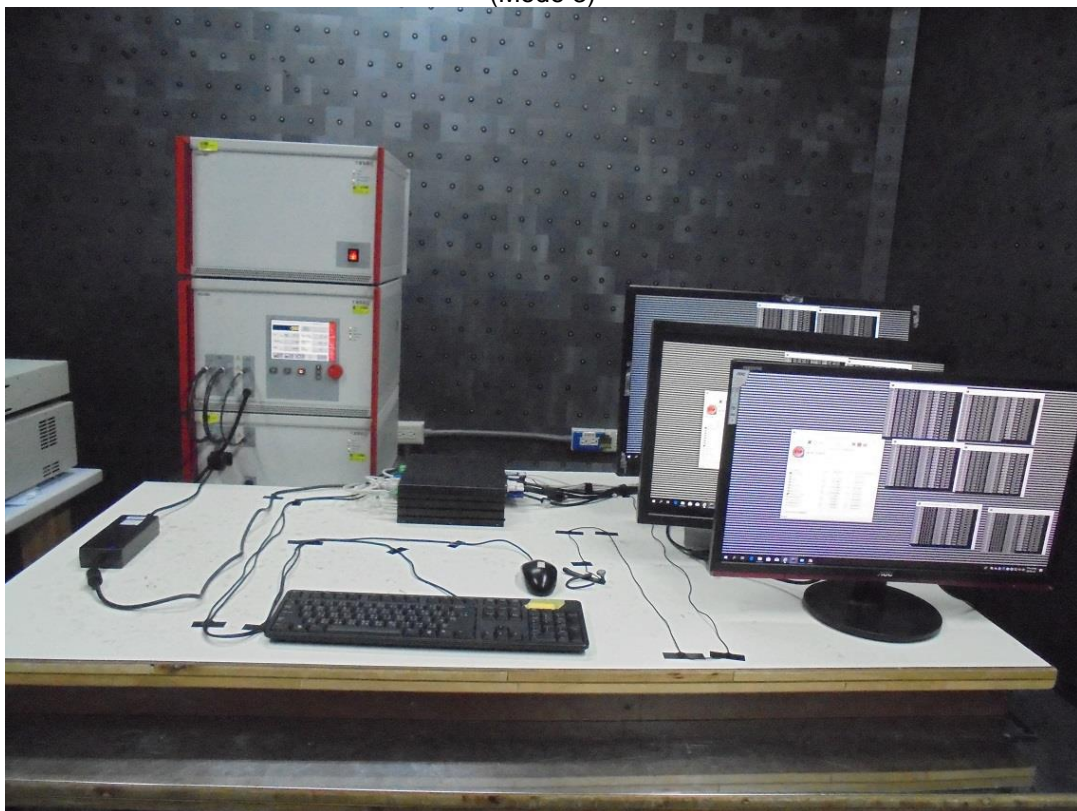

19.10 Conducted Disturbances Induced by RF Fields (CS)

(Mode 1)

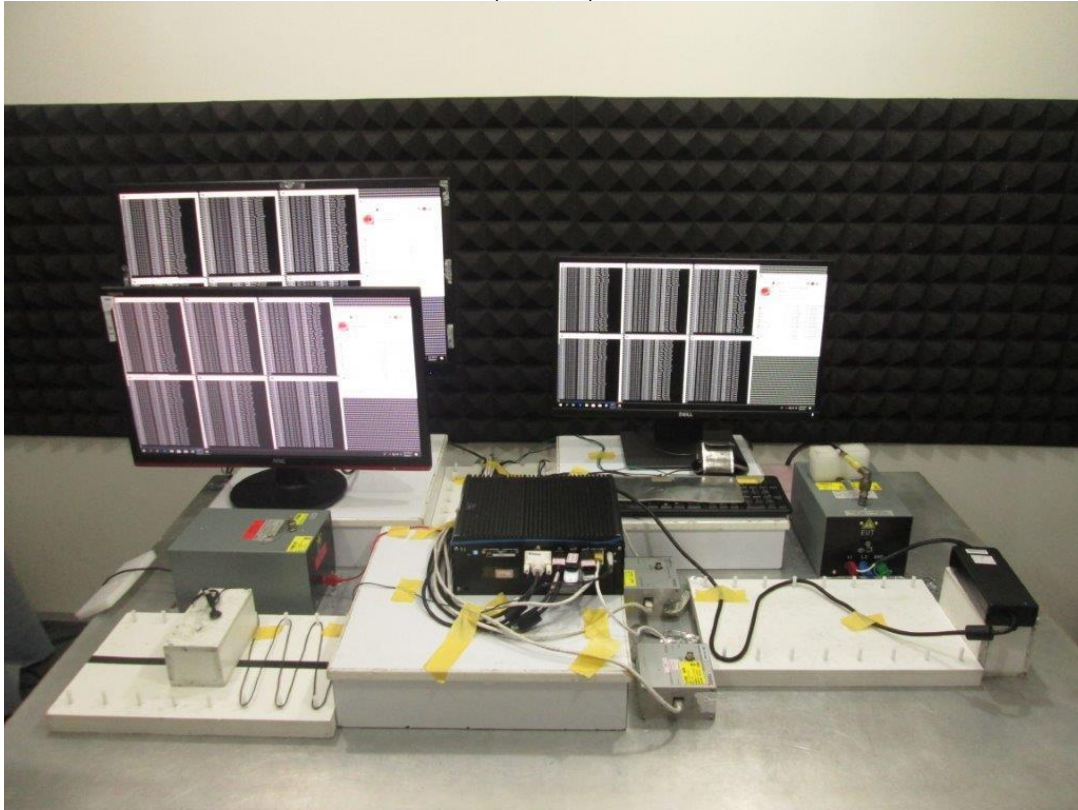

(Mode 2)

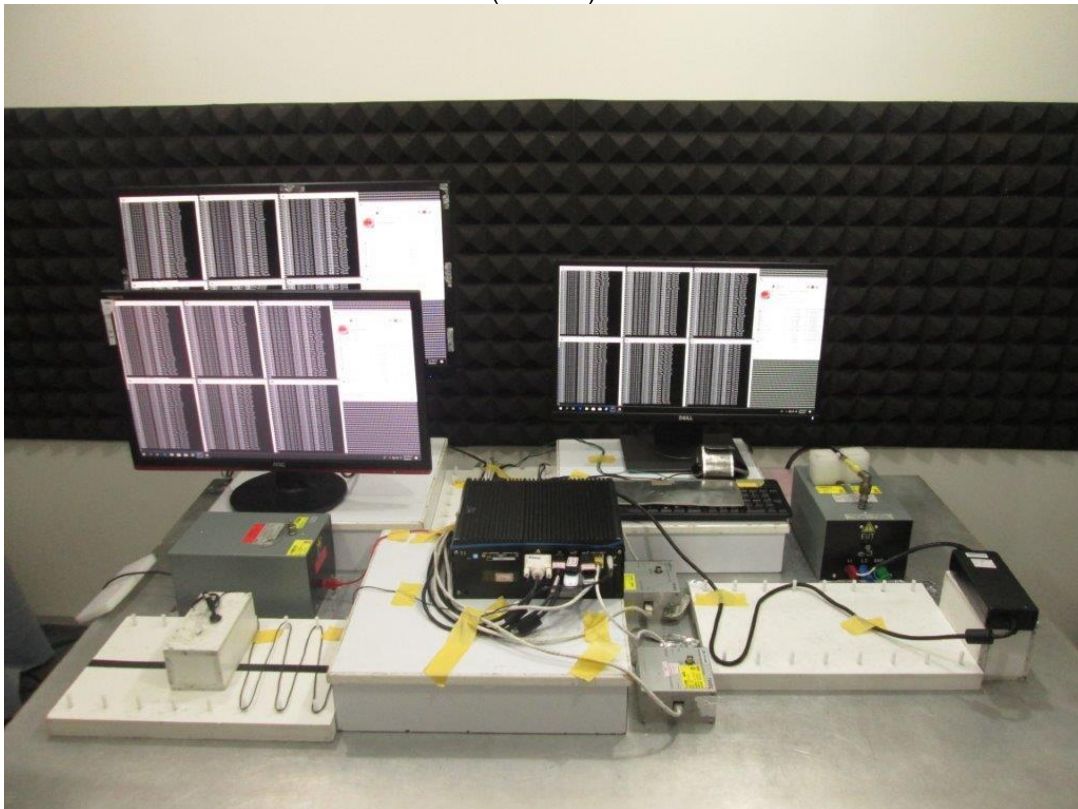

(Mode 3)

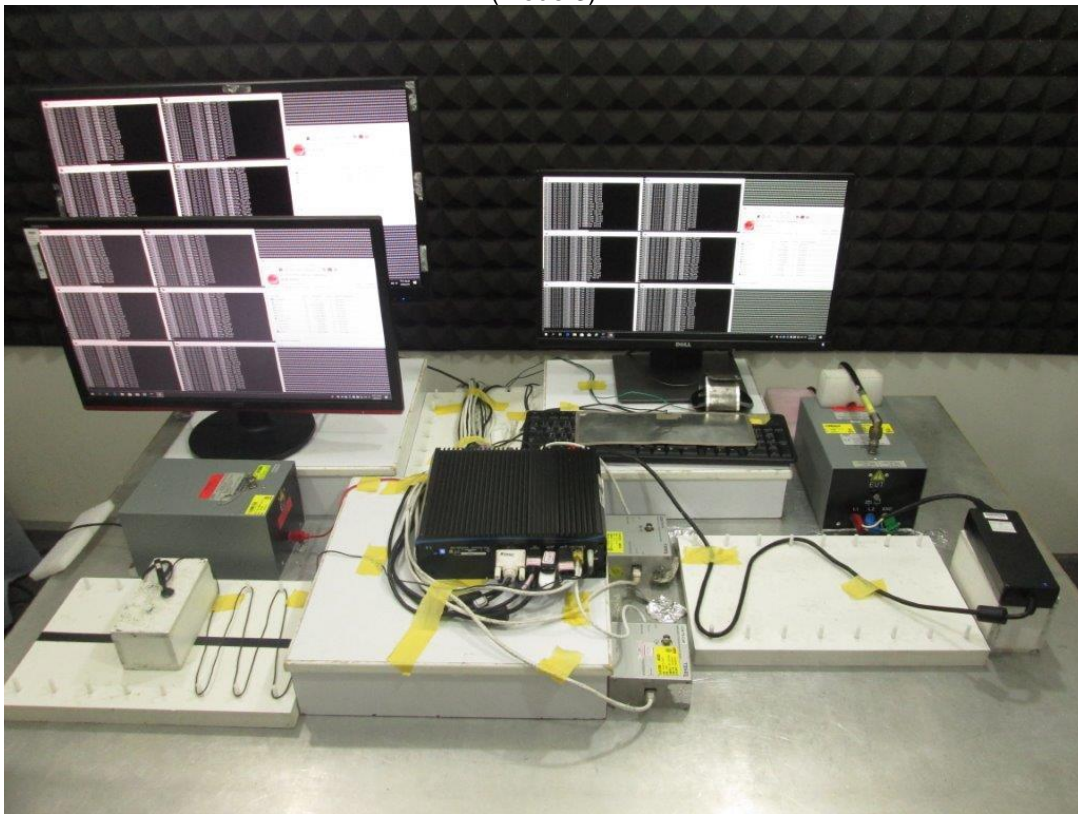

(Mode 4)

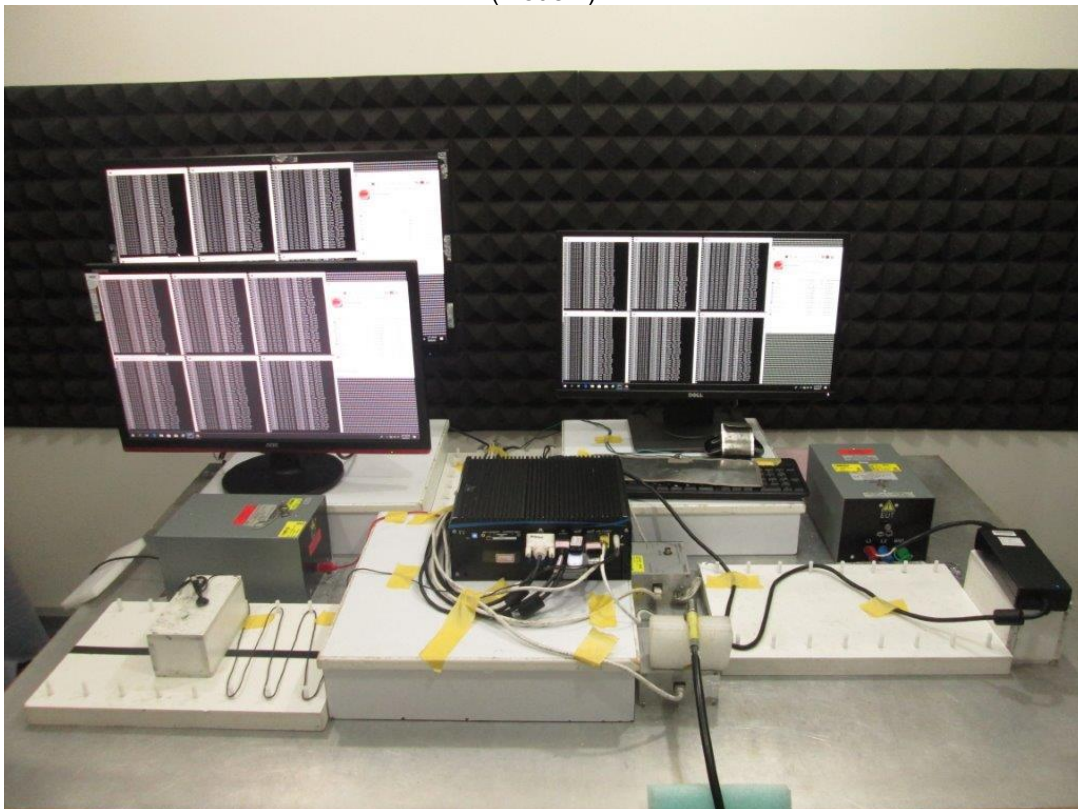

(Mode 5)

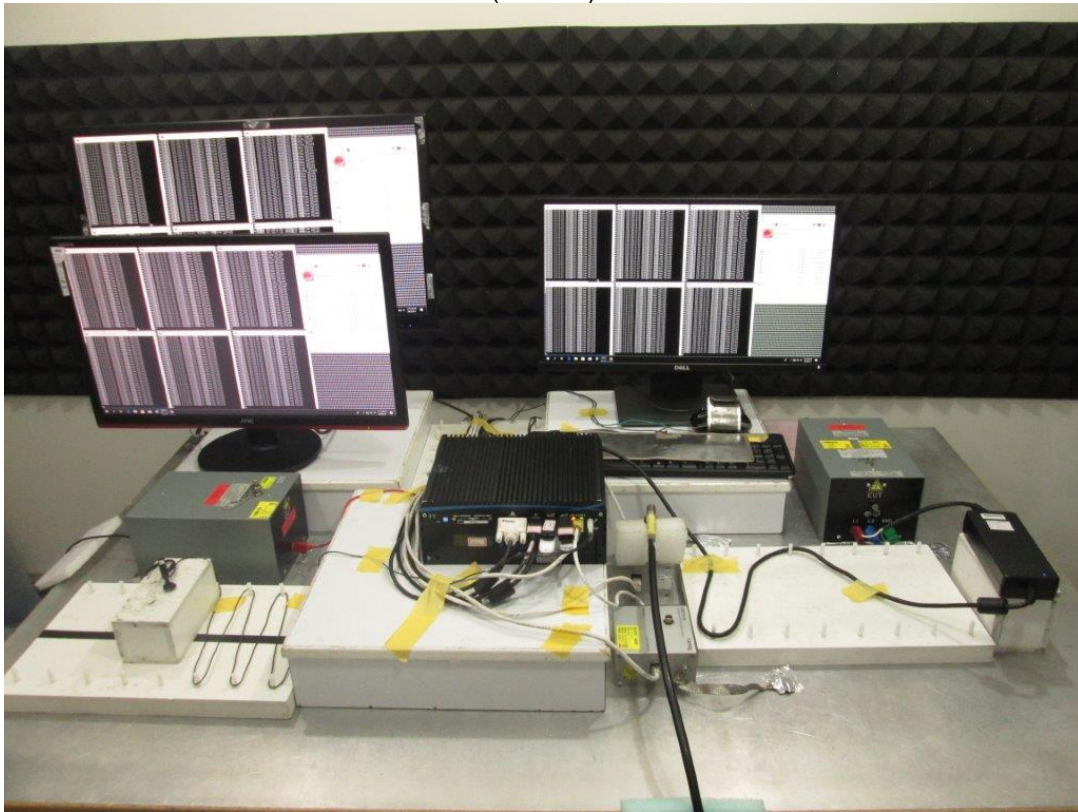

(Mode 6)

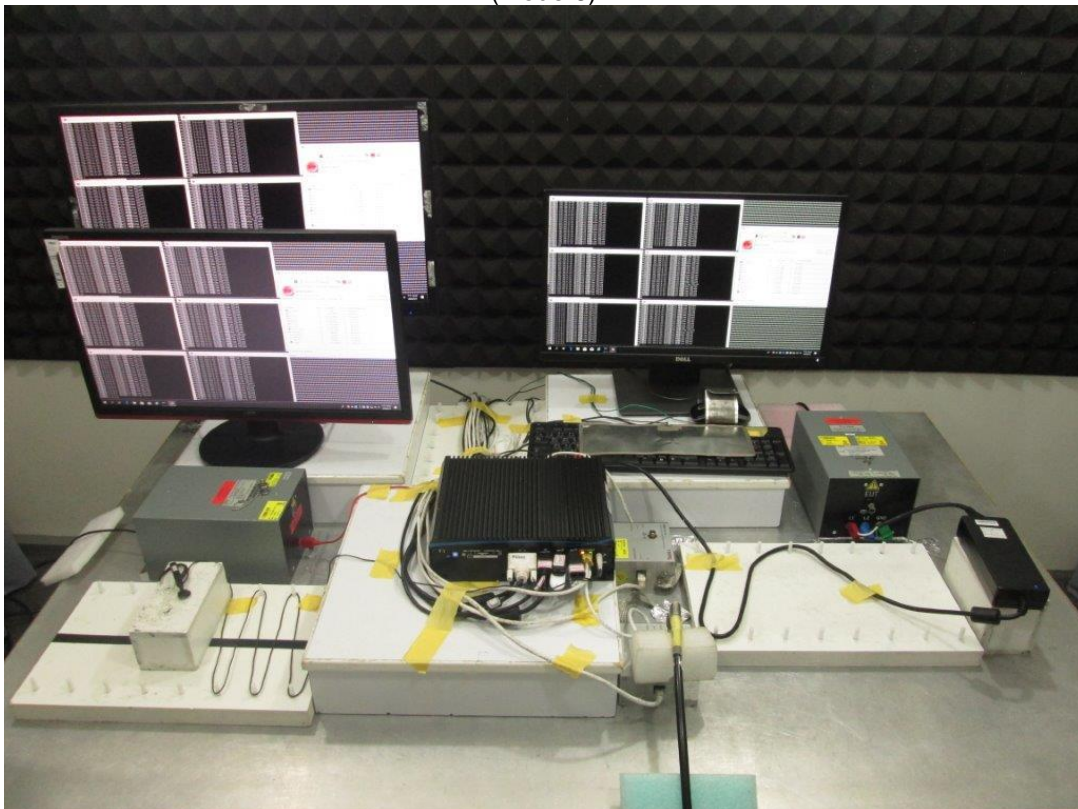

(Mode 7)

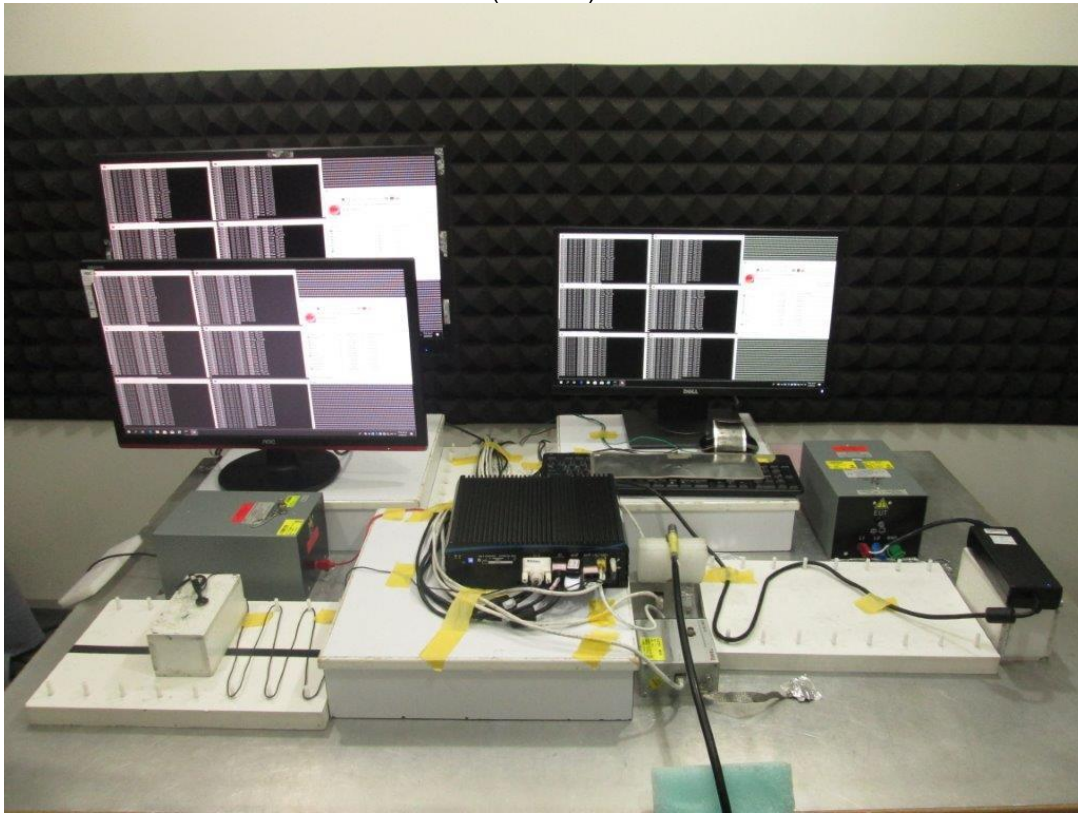

19.11 Power Frequency Magnetic Field Immunity Test (PFMF)

(Mode 1)

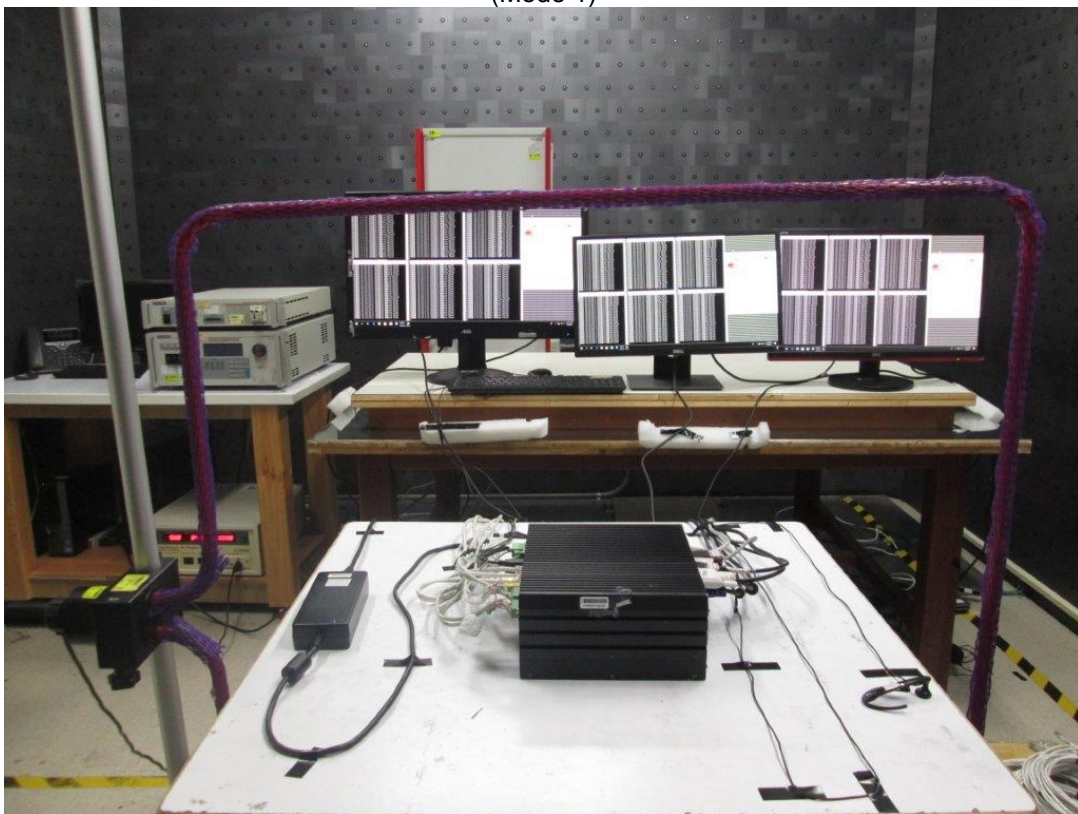

(Mode 2)



(Mode 3)



19.12 Voltage Dips and Interruptions

(Mode 1)



(Mode 2)



(Mode 3)



Appendix – Information of the Testing Laboratories

We, Bureau Veritas Consumer Products Services (H.K.) Ltd., Taoyuan Branch, were founded in 1988 to provide our best service in EMC, Radio, Telecom and Safety consultation. Our laboratories are accredited and approved according to ISO/IEC 17025.

If you have any comments, please feel free to contact us at the following:

Lin Kou EMC/RF Lab

Tel: 886-2-26052180

Fax: 886-2-26051924

Hsin Chu EMC/RF/Telecom Lab

Tel: 886-3-6668565

Fax: 886-3-6668323

Hwa Ya EMC/RF/Safety Lab

Tel: 886-3-3183232

Fax: 886-3-3270892

Email: service.adt@tw.bureauVeritas.com

Web Site: www.bureauVeritas-adt.com

The address and road map of all our labs can be found in our web site also.

--- END ---